

SAW Filter 1176.45 MHz SMD 3.0×3.0mm

MODEL NO.: TA2493A

REV. 2.0

A. MAXIMUM RATING:

1. Input Power Level: 20 dBm
2. DC Voltage : 3 V
3. Operating Temperature: -55 °C to +85 °C
4. Storage Temperature: -55 °C to +85 °C
5. Moisture Sensitive Level: Level 1 (MSL1)



Electrostatic Sensitive Device (ESD)

B. ELECTRICAL CHARACTERISTICS:

Terminating source impedance: $Z_s = 50 \Omega$

Terminating load impedance: $Z_L = 50 \Omega$

Item	Unit	Min.	Typ.	Max.
Center Frequency	MHz	-	1176.45	-
Insertion Loss (1166.23 ~ 1186.67 MHz)	dB	-	1.9	3.5
Amplitude Ripple (1166.23 ~ 1186.67 MHz)	dB	-	0.9	2.0
Group Delay Ripple (1166.23 ~ 1186.67 MHz)	ns	-	16	25
Attenuation				
10 ~ 1100 MHz	dB	25	37	-
1149.34 MHz	dB	20	26	-
1155 MHz	dB	10	14	-
1195 MHz	dB	5	13	-
1200.45 MHz	dB	15	26	-
1210 ~ 2000 MHz	dB	25	41	-

C. MEASUREMENT CIRCUIT:

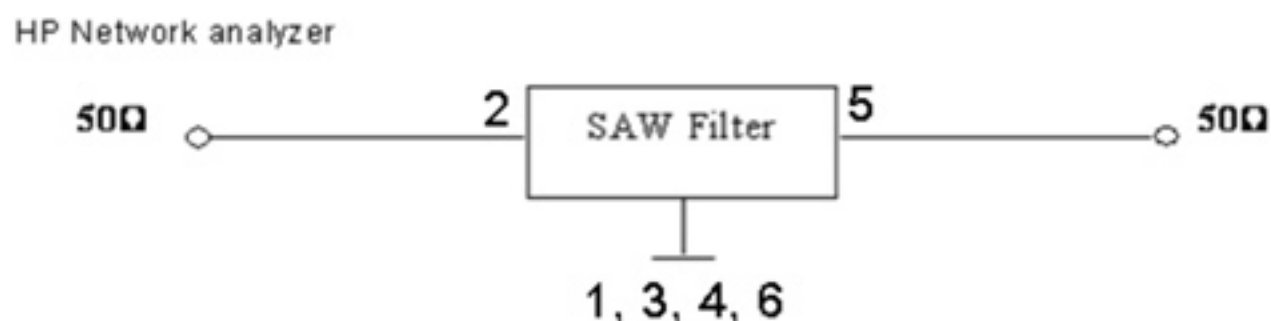

D. Frequency Characteristics:

Span 200 MHz

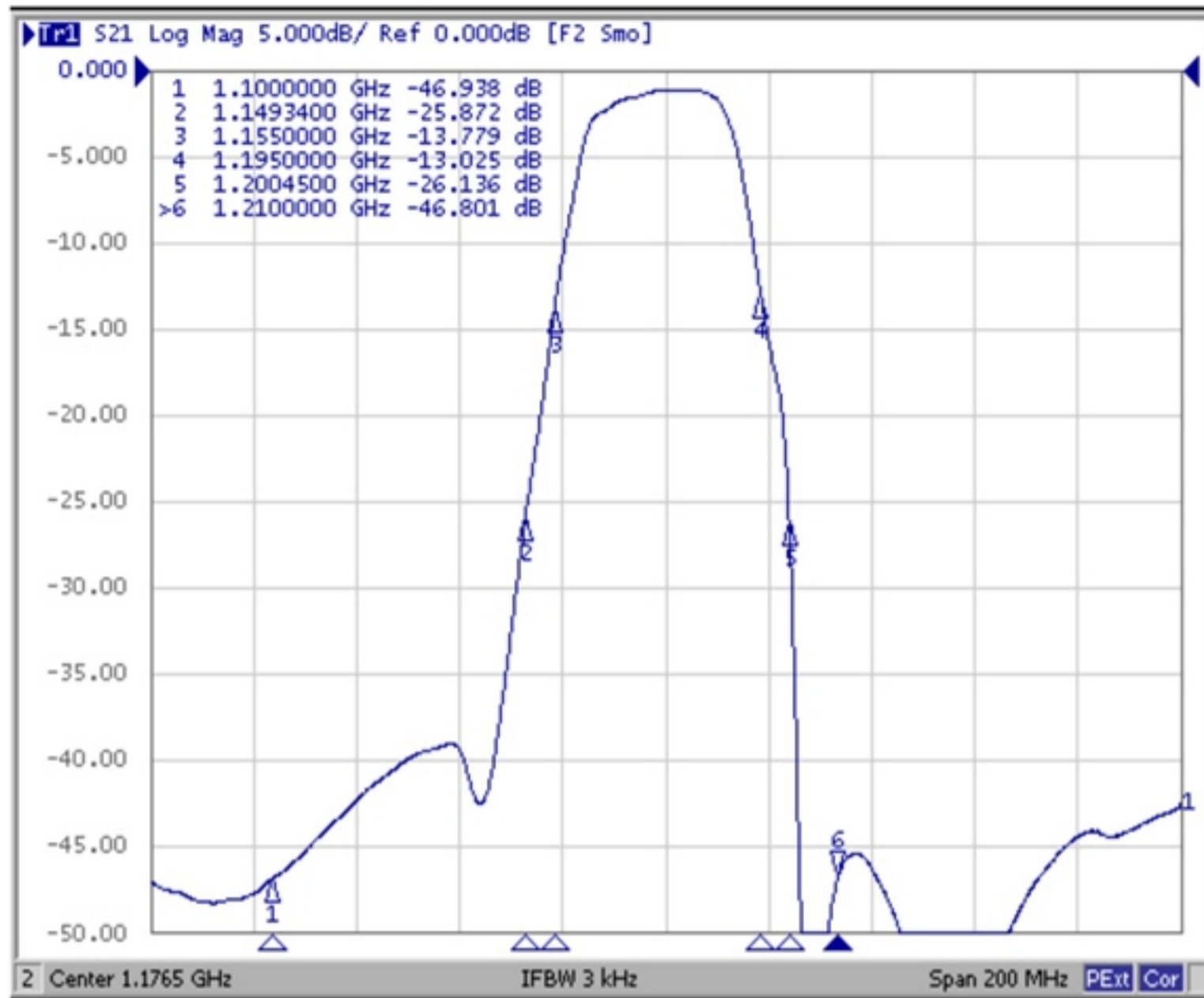

Span 2000 MHz

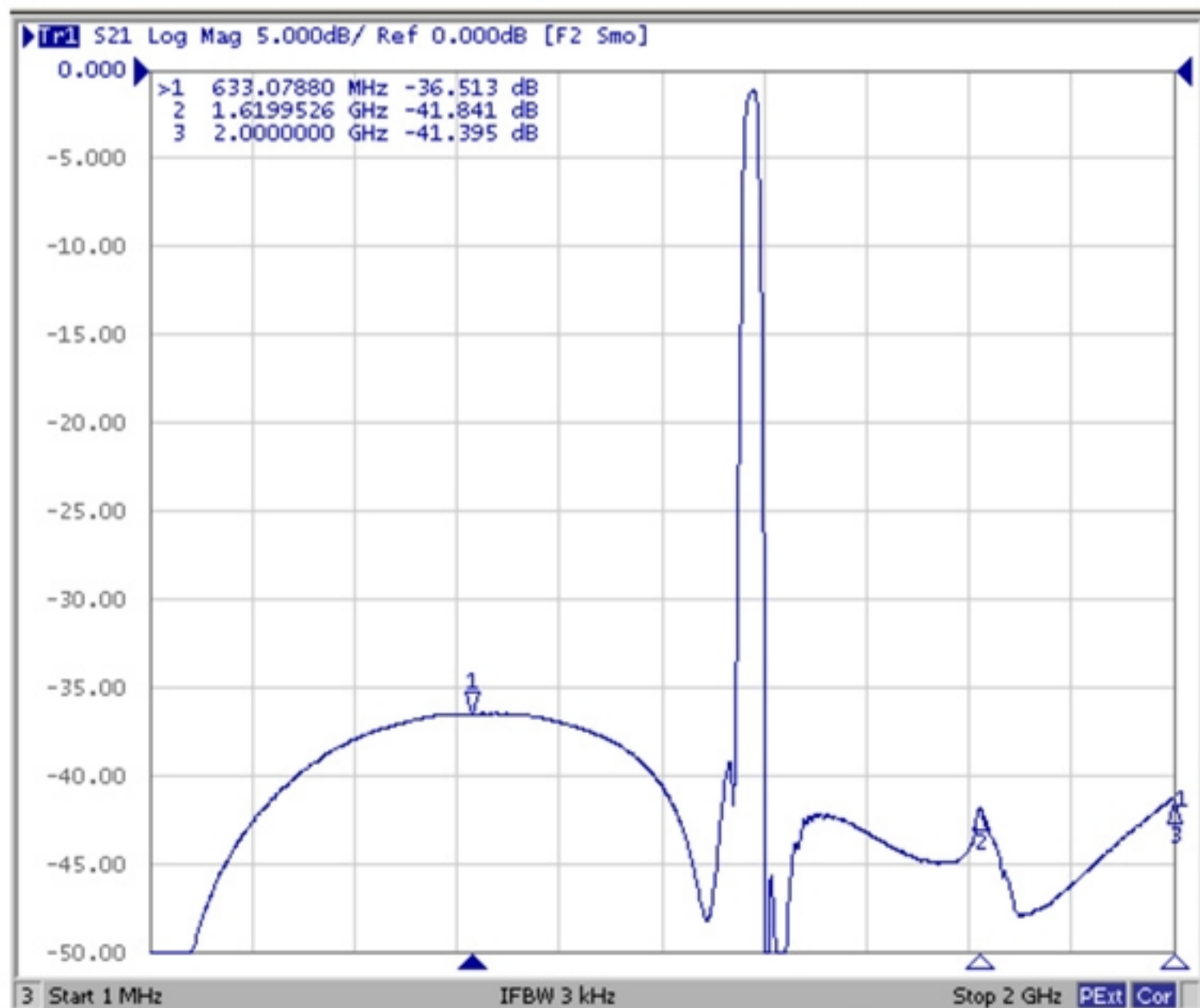

Span 50 MHz

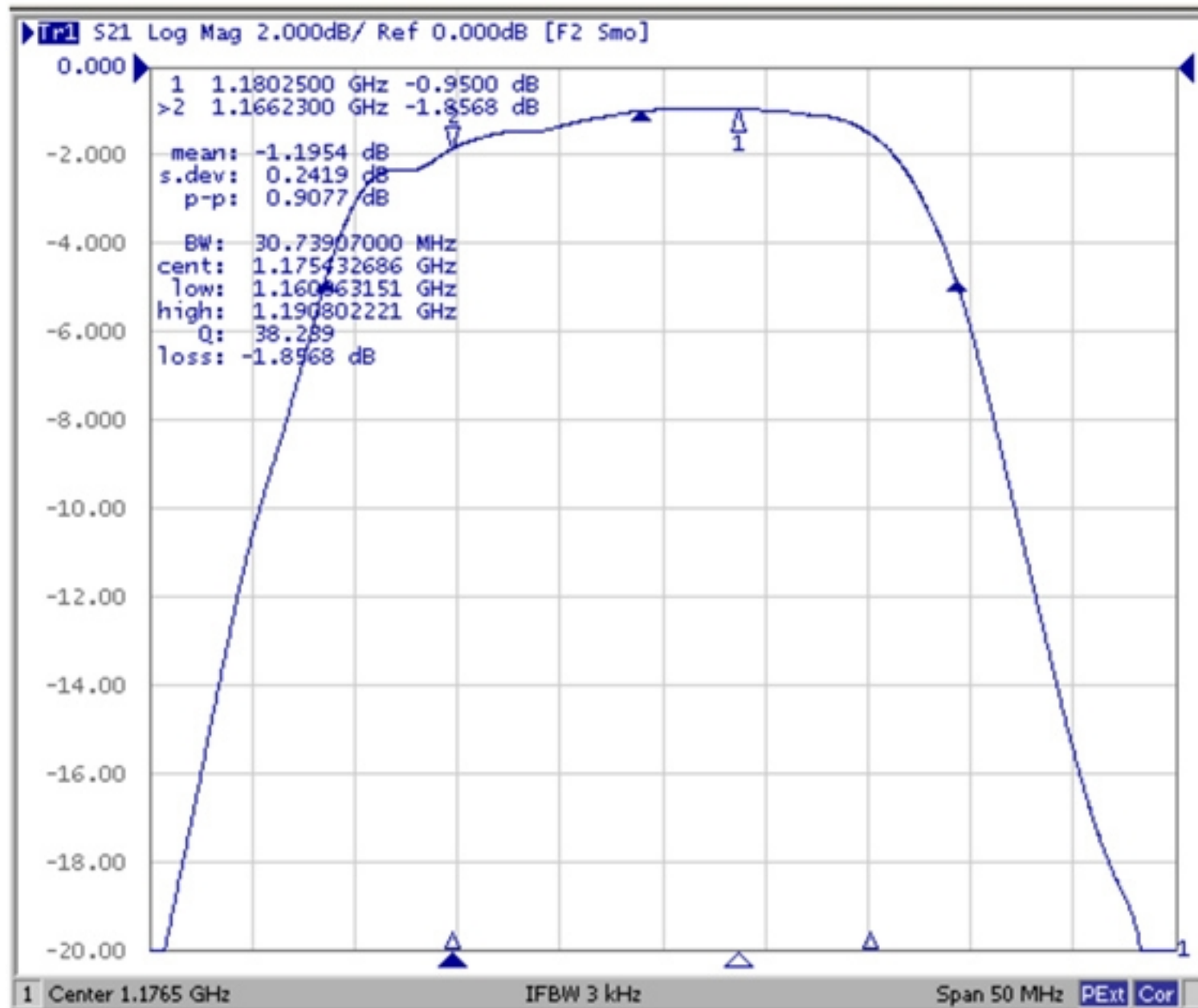

Reflective characteristics

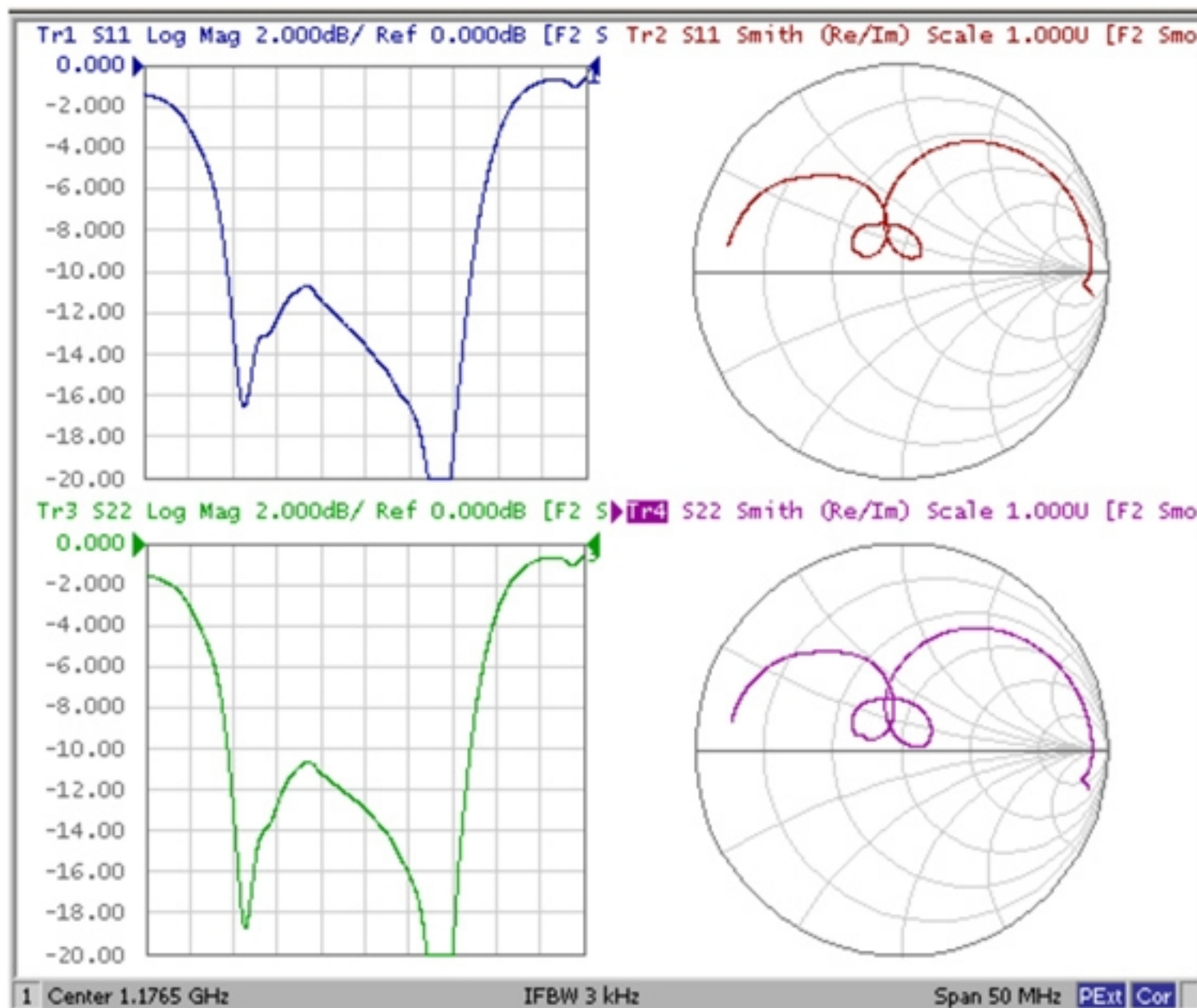

E. OUTLINE DRAWING:

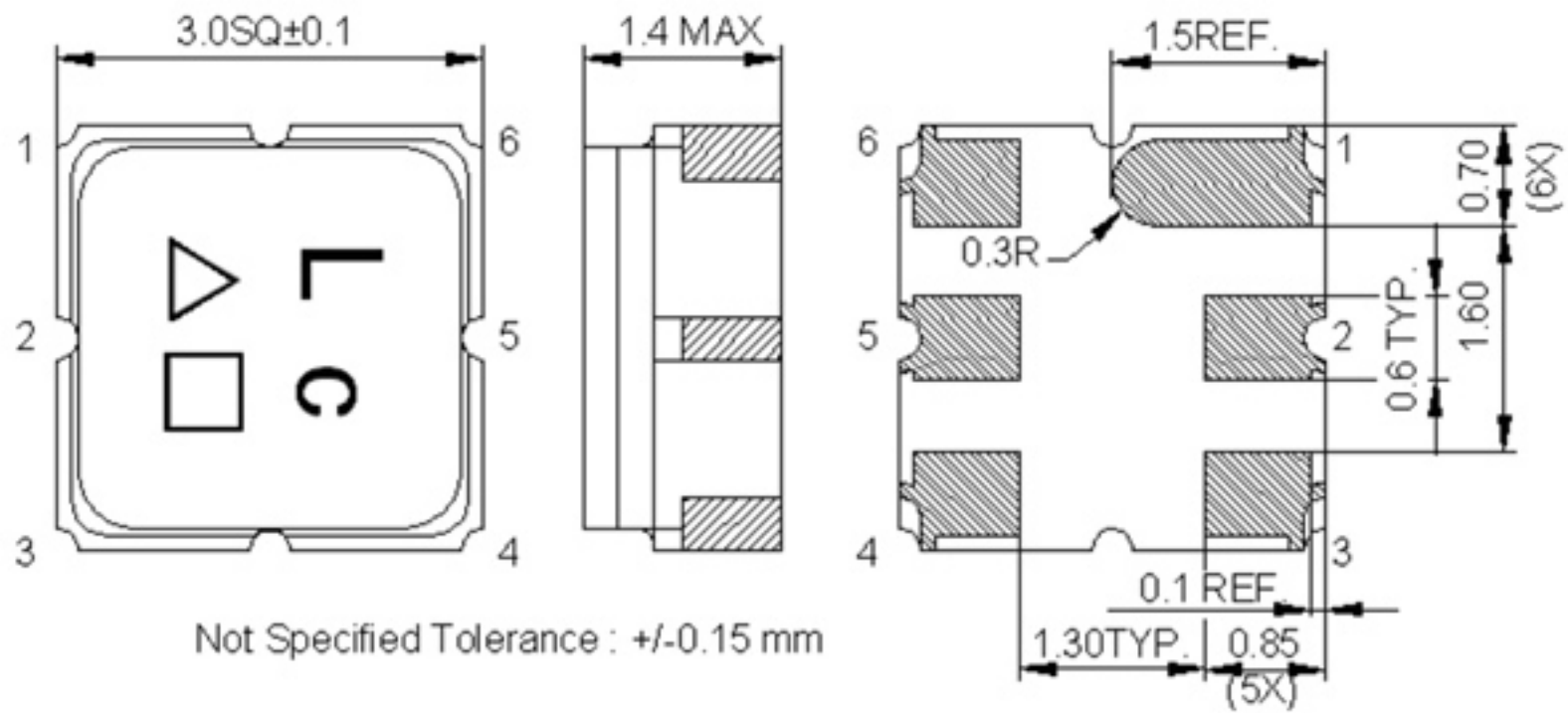

Not Specified Tolerance : $\pm 0.15 \text{ mm}$

- #2: Input
- #5: Output
- #1, 3, 4, 6: Ground

Δ : Year Code (2009->9, 2010->0, ..., 2018->8)

\square : Date Code (Follow the table from planner each year)

WK01	WK02	WK03	WK04	WK05	WK06	WK07	WK08	WK09	WK10	WK11	WK12	WK13
A	B	C	D	E	F	G	H	I	J	K	L	M
WK14	WK15	WK16	WK17	WK18	WK19	WK20	WK21	WK22	WK23	WK24	WK25	WK26
N	O	P	Q	R	S	T	U	V	W	X	Y	Z
WK27	WK28	WK29	WK30	WK31	WK32	WK33	WK34	WK35	WK36	WK37	WK38	WK39
a	b	c	d	e	f	g	h	i	j	k	l	m
WK40	WK41	WK42	WK43	WK44	WK45	WK46	WK47	WK48	WK49	WK50	WK51	WK52
n	o	p	q	r	s	t	u	v	w	x	y	z

F. PCB Footprint:

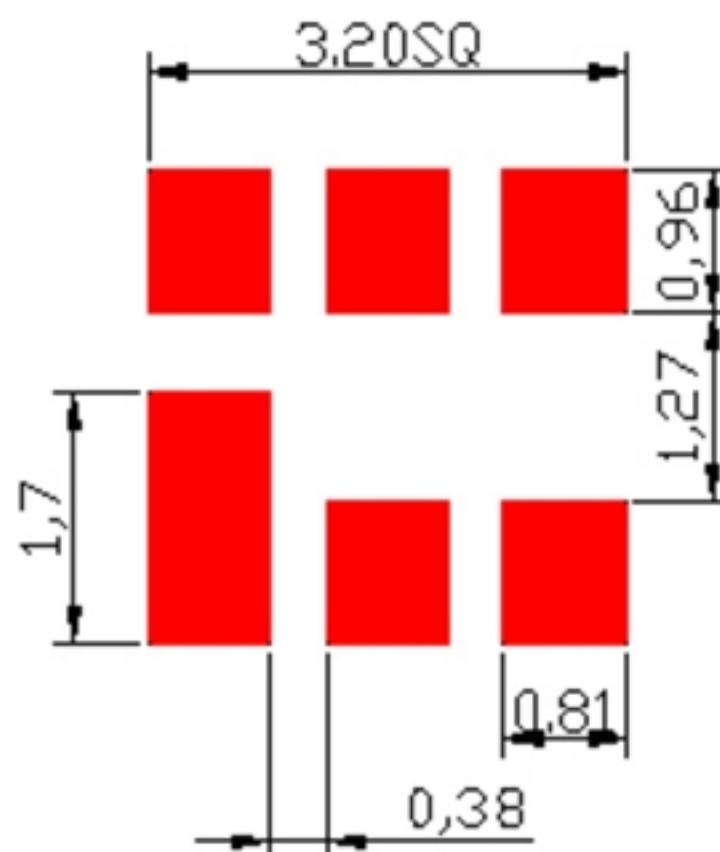

G. PACKING:

1. REEL DIMENSION

(Please refer to FR-75D10 for packing quantity)

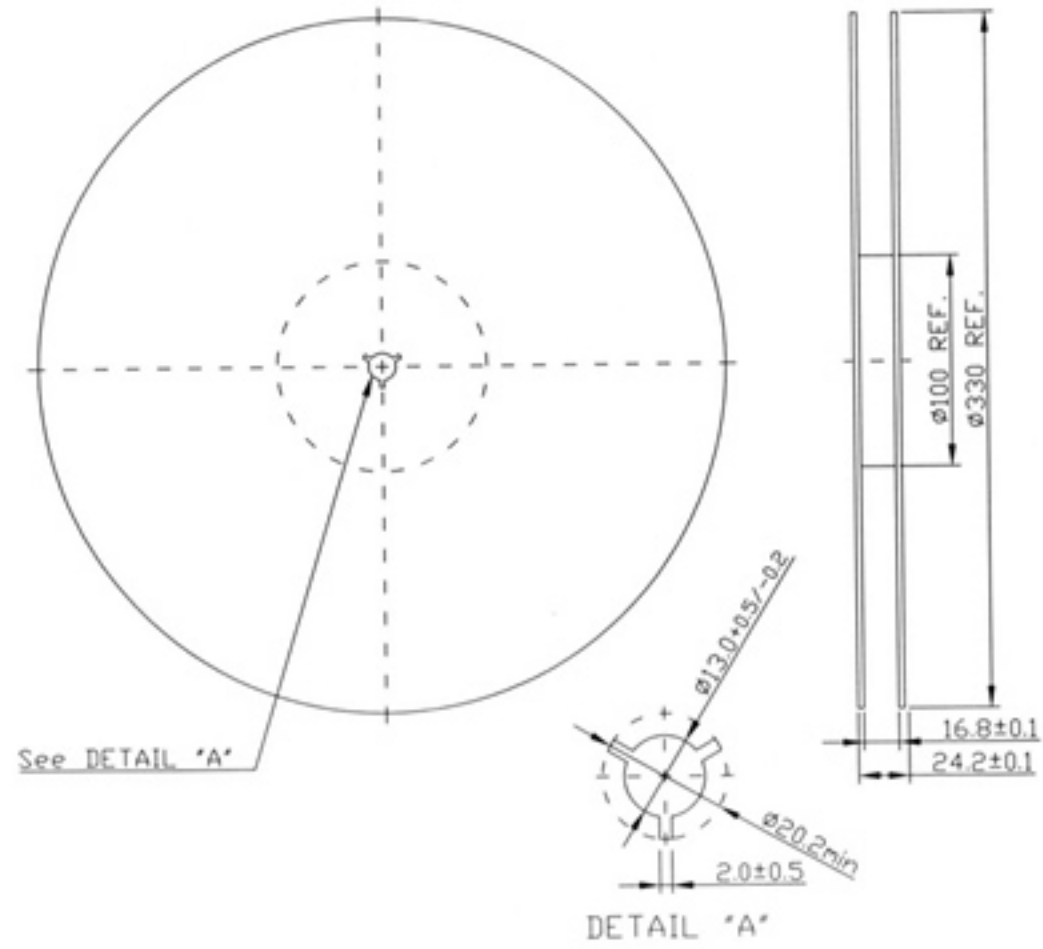

2. TAPE DIMENSION

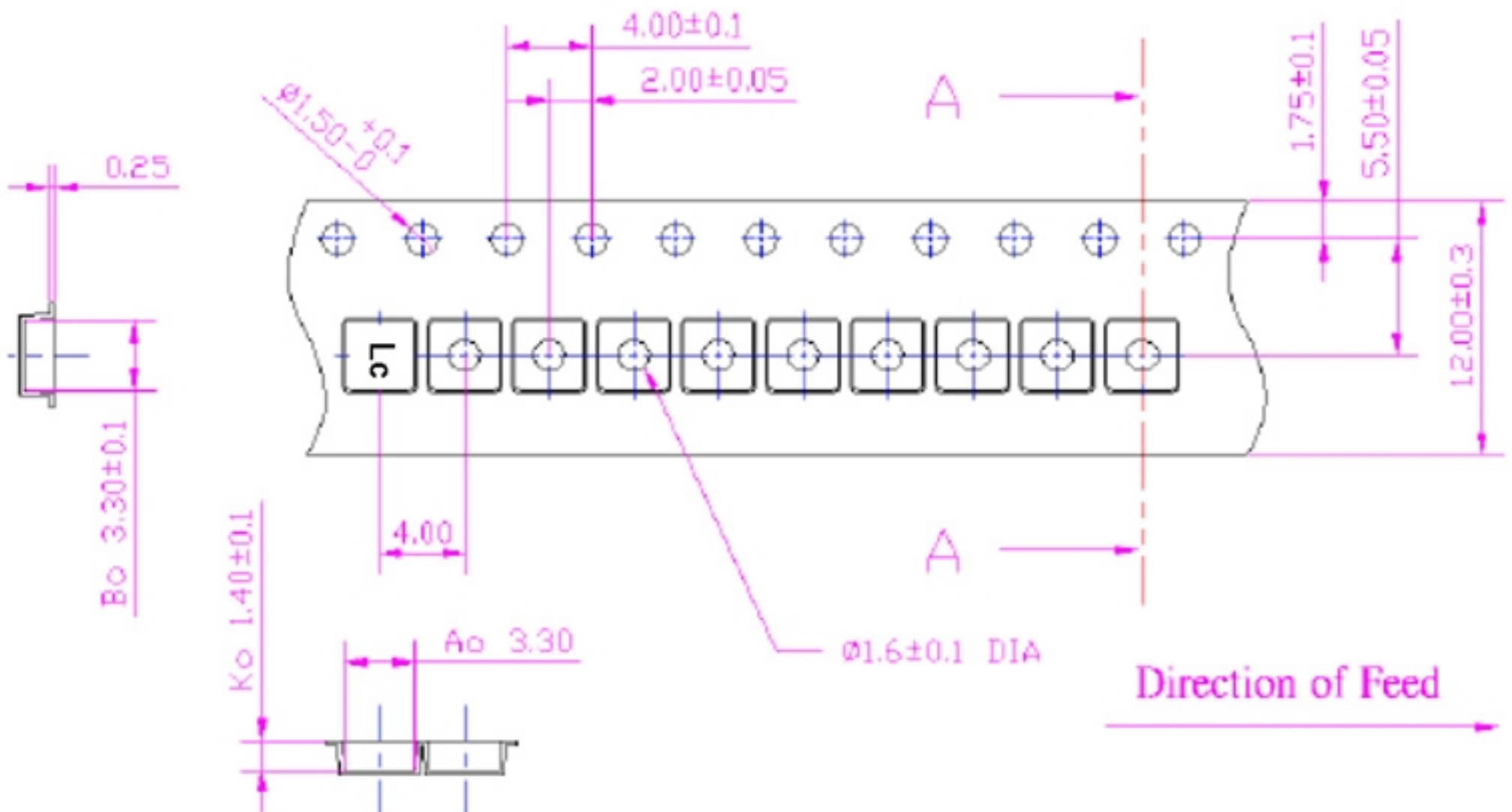

H. RECOMMENDED REFLOW PROFILE:

1. Preheating shall be fixed at $150\sim 180^{\circ}\text{C}$ for $60\sim 90$ seconds.
2. Ascending time to preheating temperature 150°C shall be 30 seconds min.
3. Heating shall be fixed at 220°C for $50\sim 80$ seconds and at $260^{\circ}\text{C} + 0/-5^{\circ}\text{C}$ peak ($20\sim 40$ sec).
4. Time: 2 times.

