

SAW Filter 1176.45MHz BW20MHz SMD 1.1x0.9mm

MODEL NO.:TA2543A

REV. NO.:1.0

A. MAXIMUM RATING:

1. Input Power Level: 13 dBm (2000h)
2. DC Voltage : 3 V
3. Operating Temperature: -20 °C to +85 °C
4. Storage Temperature: -40 °C to +85 °C
5. ESD Machine Mode : 50V
6. ESD Human Body Mode : 100V
7. Moisture Sensitive Level (MSL): Level 2a

RoHS Compliant
Lead free
Lead-free soldering

Electrostatic Sensitive Device (ESD)

B. ELECTRICAL CHARACTERISTICS:

Temperature range for specification : $T_{spec} = -20\text{ °C to }+85\text{ °C}$

Terminating source impedance : $Z_s = 50\ \Omega$

Terminating load impedance : $Z_L = 50\ \Omega$

Item	Unit	Min.	Typ.	Max.
Center Frequency Fc	MHz	-	1176.45	-
Insertion Loss (1166.45~1186.45 MHz) IL	dB	-	1.4	2
Amplitude Ripple (1166.45~1186.45 MHz)	dB _{p-p}	-	0.4	1.3
VSWR (1166.45~1186.45 MHz)		-	1.6	2.1
Attenuation (refer to 0 dB)				
100 ~ 1080 MHz	dB	30	44	-
1080 ~ 1130 MHz	dB	20	26	-
1230 ~ 2000 MHz	dB	30	32	-
2000 ~ 3000 MHz	dB	25	29	-
Temperature Coefficient	ppm/K	-	-36	-

C.OUTLINE DRAWING:

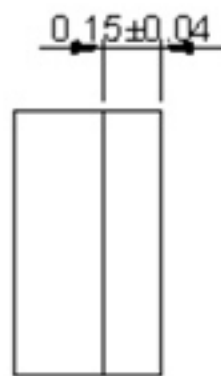
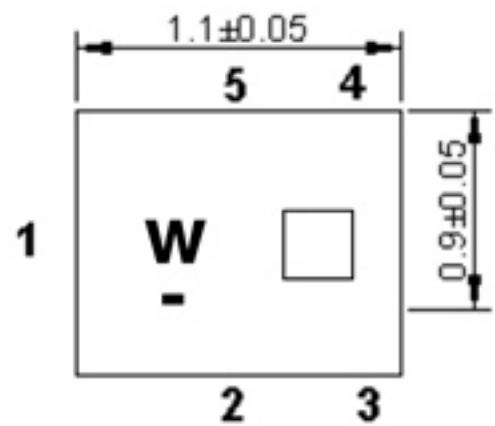

All tolerances are +/-0.05 mm unless otherwise specified

Coplanarity : 0.1 mm max.

1 to 5 : Pin No.

Unit : mm

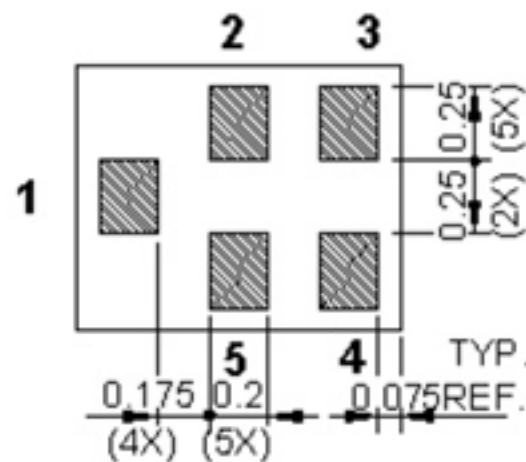

1 : Input

4 : Output

2, 3, 5 : Ground

□ : Year/Month Code (Follow the table)

YEAR/Month	1	2	3	4	5	6	7	8	9	10	11	12
2013	A	B	C	D	E	F	G	H	J	K	L	M
2014	N	P	Q	R	S	T	U	V	W	X	Y	Z
2015	a	b	c	d	e	f	g	h	j	k	l	m
2016	n	p	q	r	s	t	u	v	w	x	y	z
2017	<u>A</u>	<u>B</u>	<u>C</u>	<u>D</u>	<u>E</u>	<u>F</u>	<u>G</u>	<u>H</u>	<u>J</u>	<u>K</u>	<u>L</u>	<u>M</u>
2018	<u>N</u>	<u>P</u>	<u>Q</u>	<u>R</u>	<u>S</u>	<u>T</u>	<u>U</u>	<u>V</u>	<u>W</u>	<u>X</u>	<u>Y</u>	<u>Z</u>
2019	<u>a</u>	<u>b</u>	<u>c</u>	<u>d</u>	<u>e</u>	<u>f</u>	<u>g</u>	<u>h</u>	<u>i</u>	<u>k</u>	<u>l</u>	<u>m</u>
2020	<u>n</u>	<u>p</u>	<u>q</u>	<u>r</u>	<u>s</u>	<u>t</u>	<u>u</u>	<u>v</u>	<u>w</u>	<u>x</u>	<u>y</u>	<u>z</u>

D. MEASUREMENT CIRCUIT:

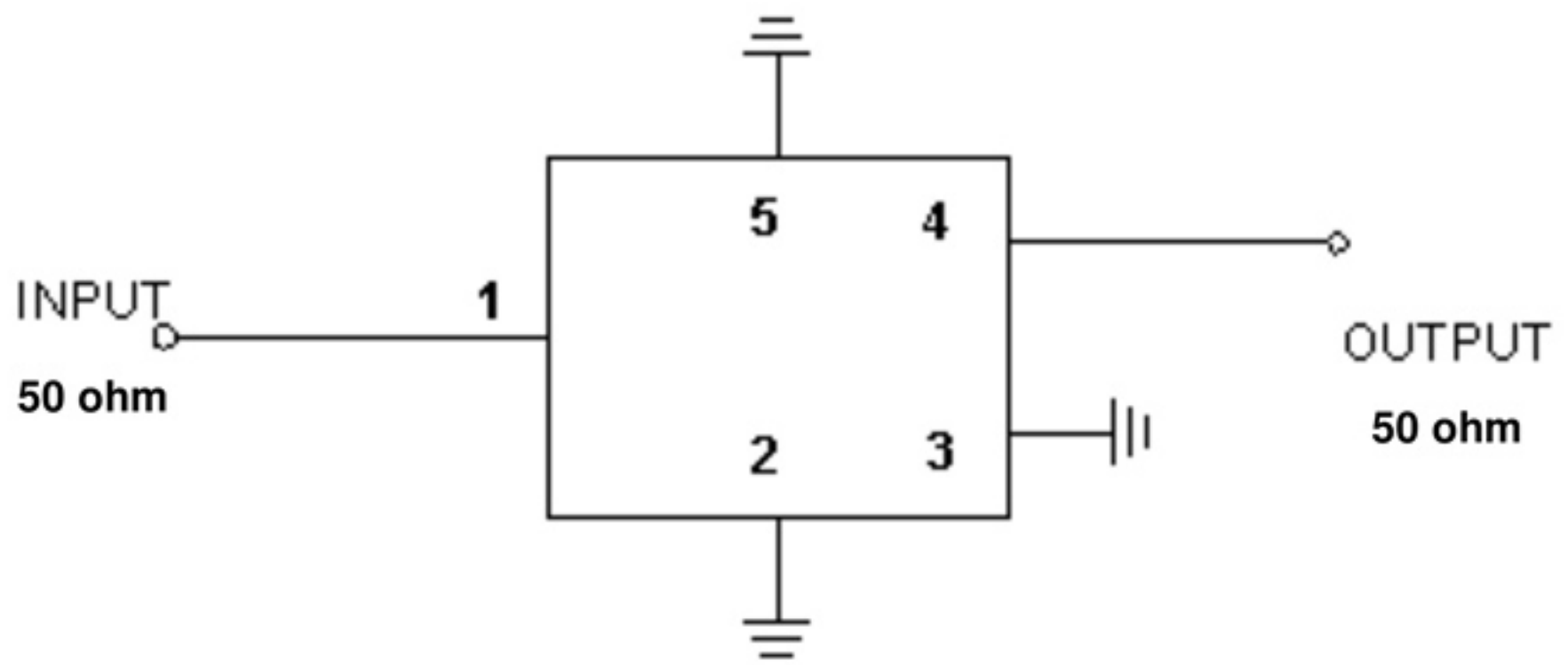

E. PCB Footprint :

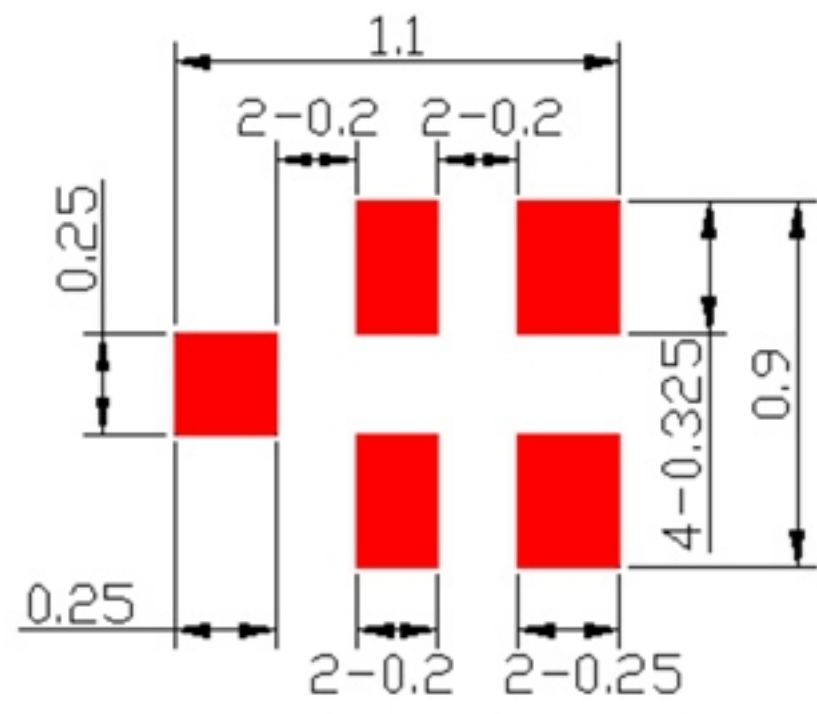

F. Frequency Characteristics:

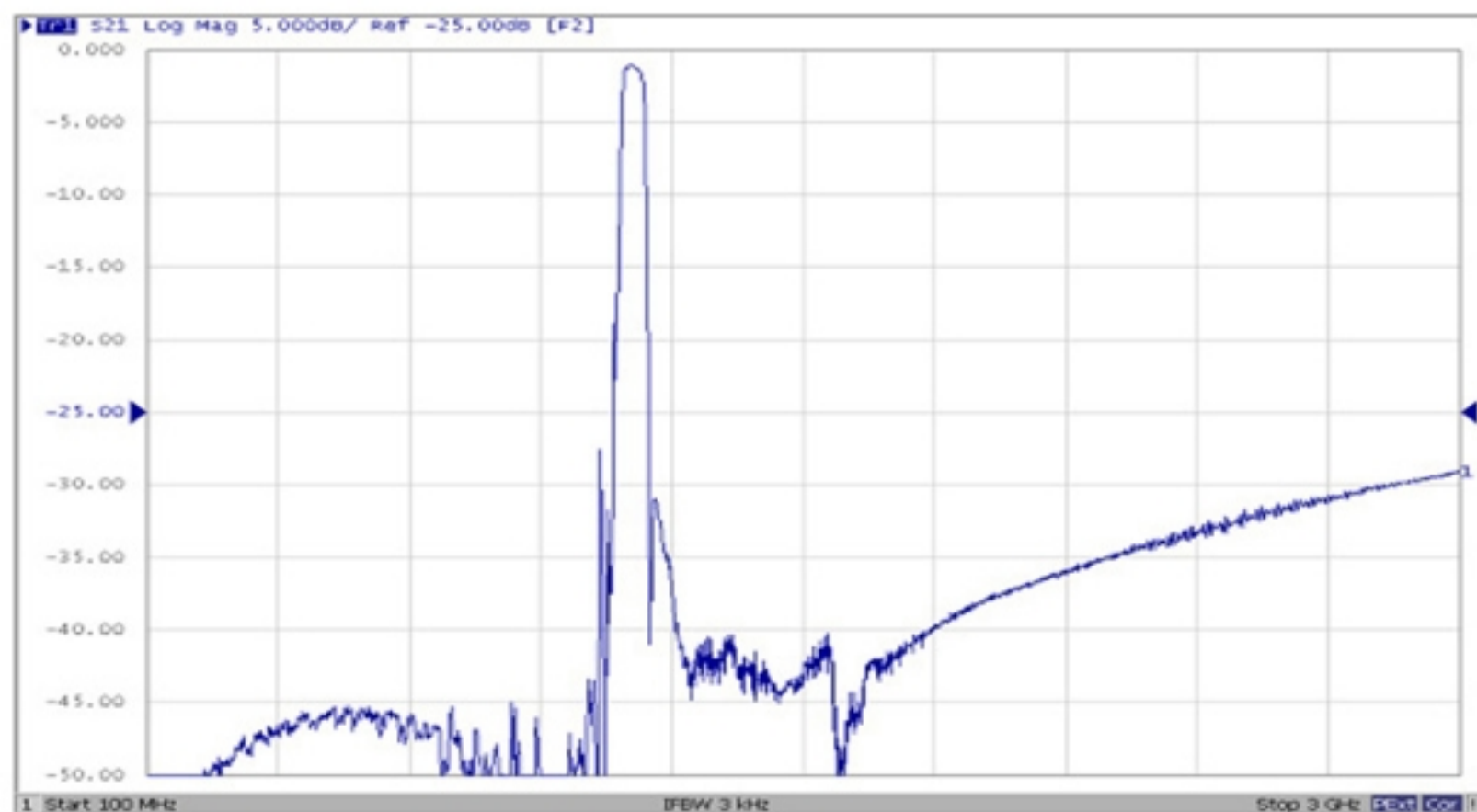
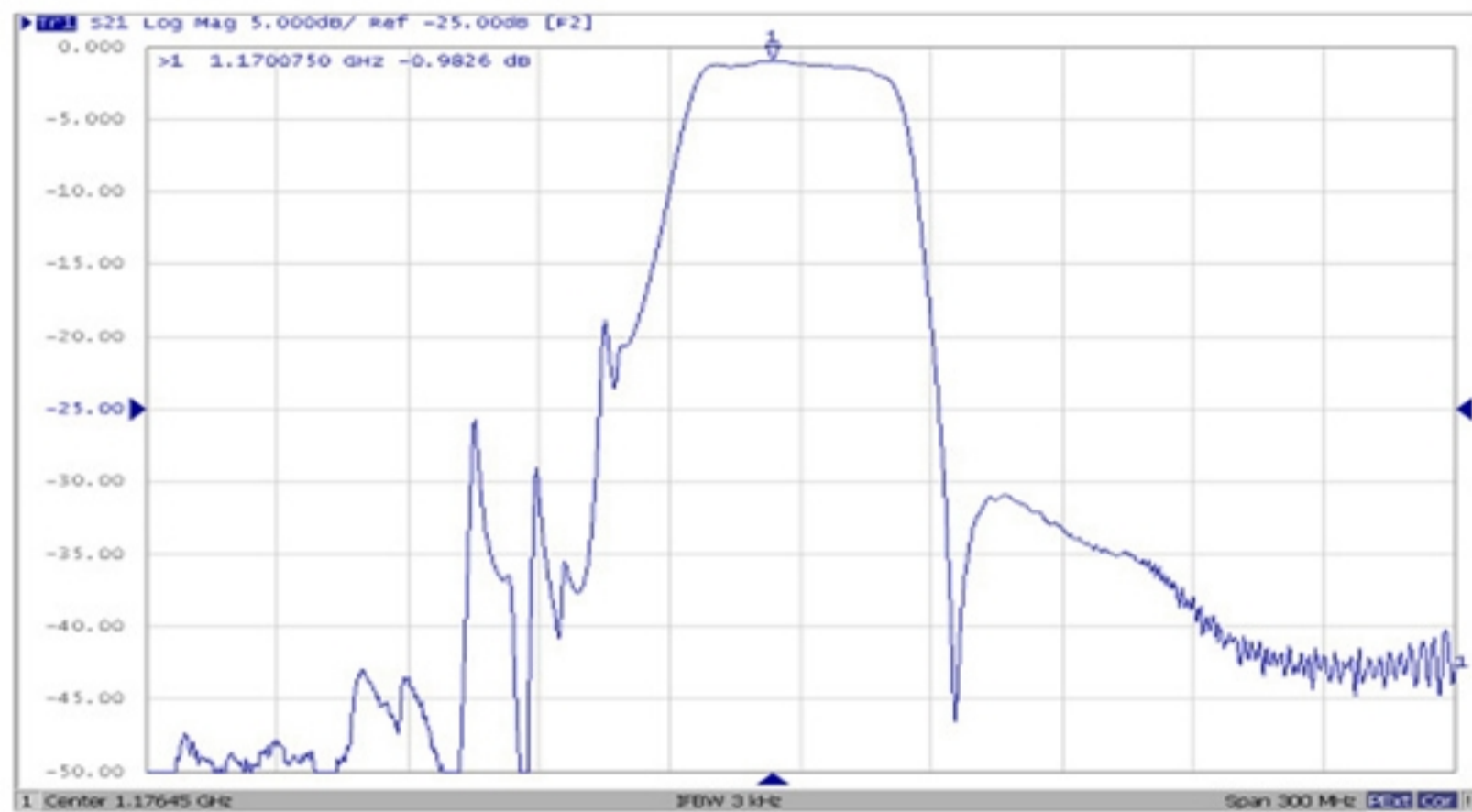
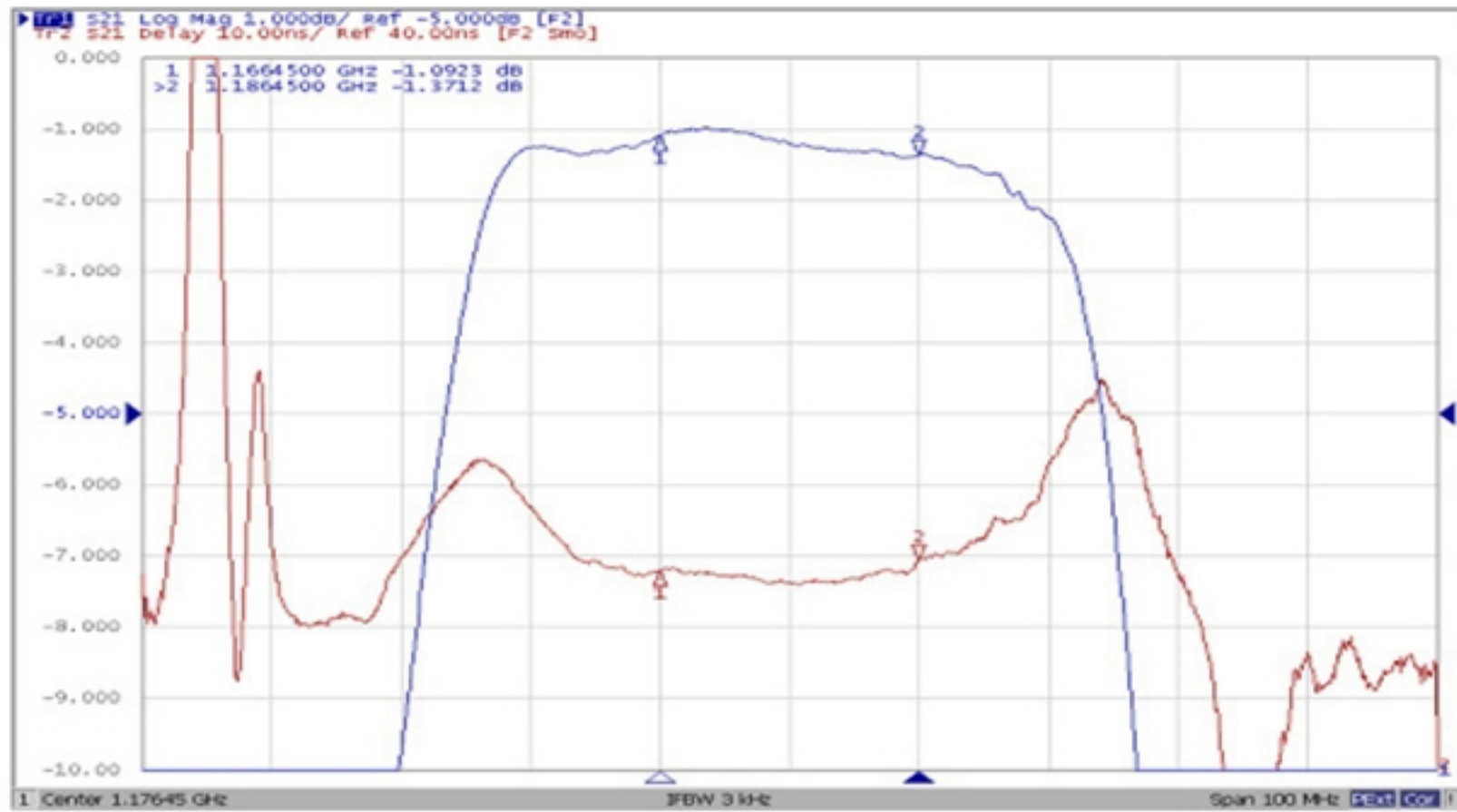

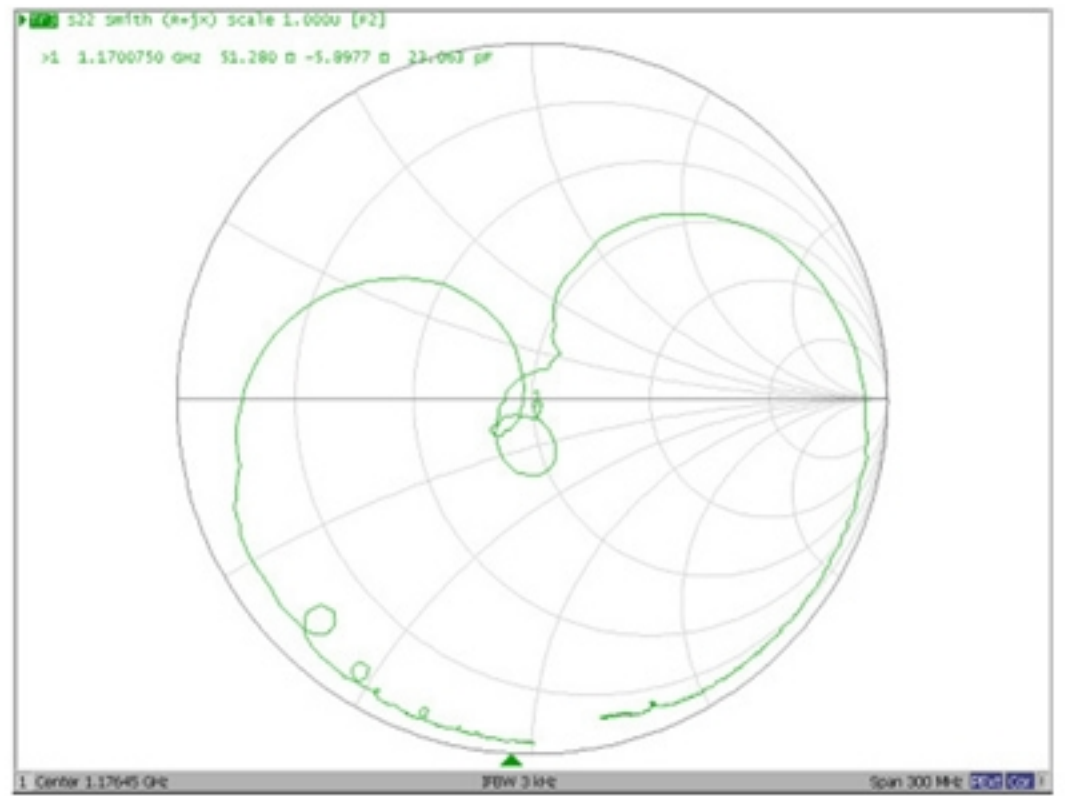
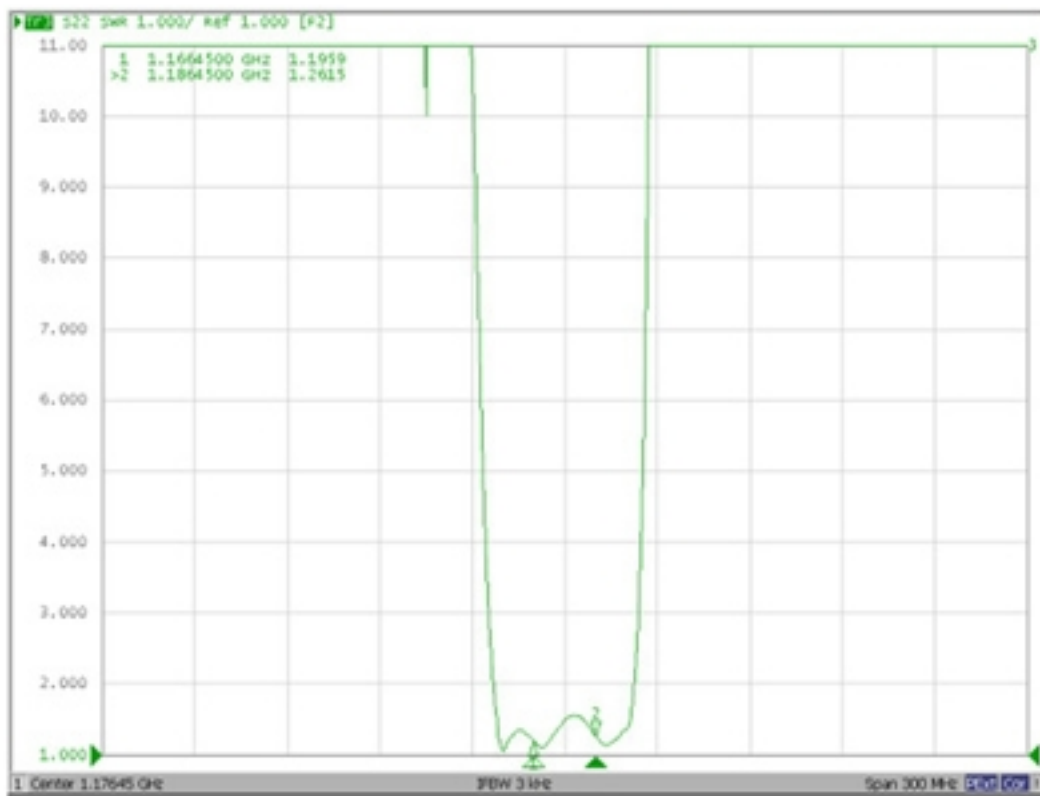
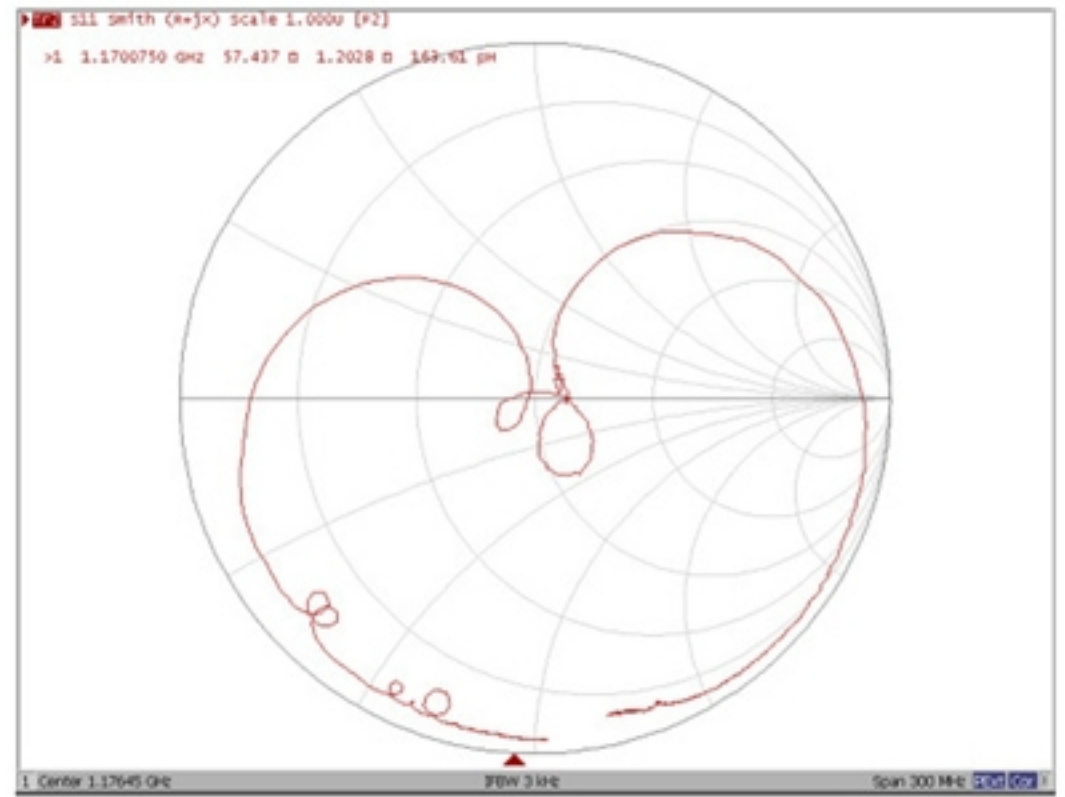
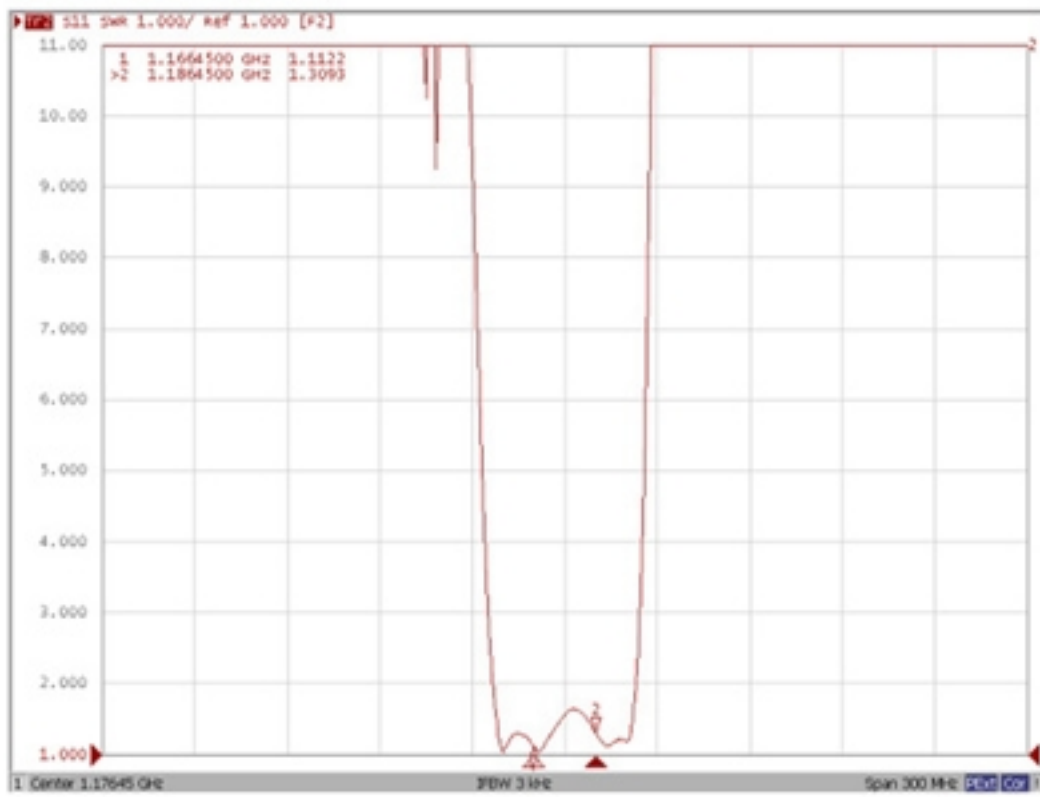

G. PACKING:

1. REEL DIMENSION

(Please refer to FR-75D10 for packing quantity)

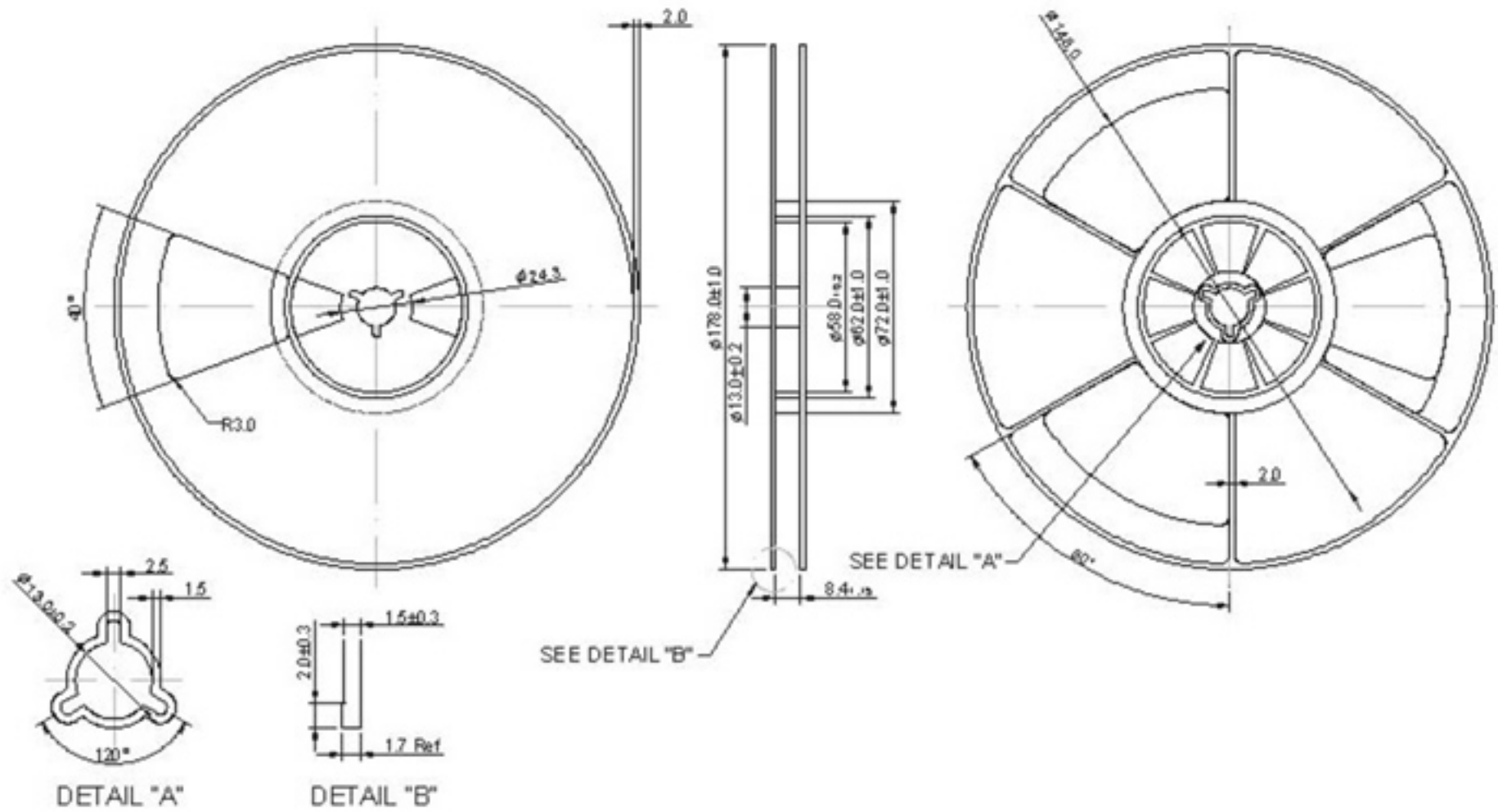

2. TAPE DIMENSION

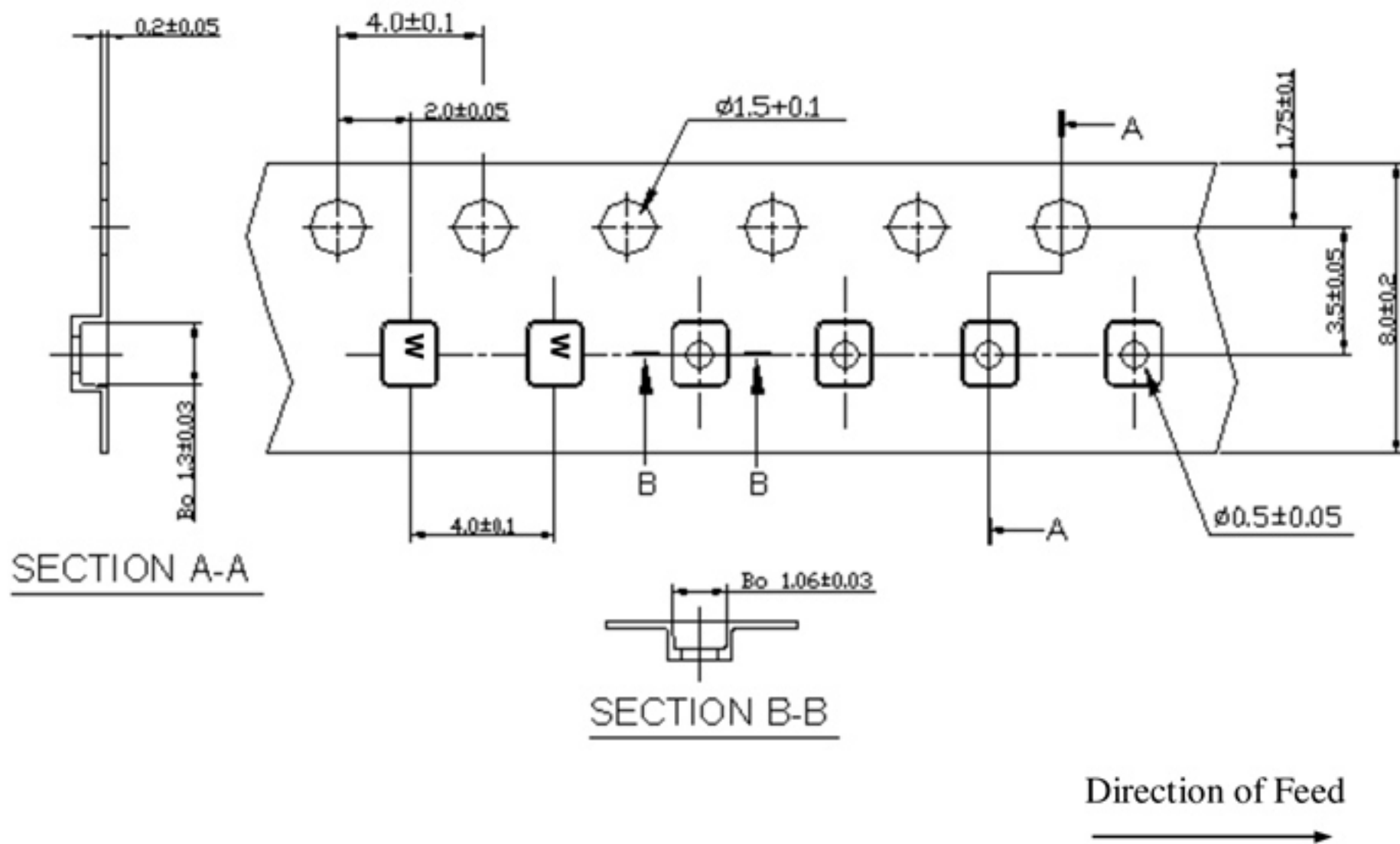

H. RECOMMENDED REFLOW PROFILE :

1. Preheating shall be fixed at $150\sim 180^{\circ}\text{C}$ for 60~90 seconds.
2. Ascending time to preheating temperature 150°C shall be 30 seconds min.
3. Heating shall be fixed at 220°C for 50~80 seconds and at $245\sim 260^{\circ}\text{C}$ peak (min. 10sec).
4. Time : 2 times.

