



TAI-SAW TECHNOLOGY CO., LTD.

No. 3, Industrial 2nd Rd., Ping-Chen Industrial District,
Taoyuan, 324, Taiwan, R.O.C.

TEL: 886-3-4690038 FAX: 886-3-4697532
E-mail: tstsales@mail.taisaw.com Web: www.taisaw.com

Product Specifications Approval Sheet

Product Name: SAW Filter 2140MHz 60MHz BW Band 1 Rx SMD 1.1×0.9 mm

TST Parts No.: TA1699D

Customer Part No.: _____

Customer signature required
Company: _____
Division: _____
Approved by : _____
Date: _____

Checked by: _____ Kazuma Lee *Kazuma Lee*

Approved by: _____ Andy Yu *Andy Yu*

Date: _____ 12, 19, 2018

1. Customer signed back is required before TST can proceed with sample build and receive orders.
2. Orders received without customer signed back will be regarded as agreement on the specifications.
3. Any specifications changes must be approved upon by both parties and a new revision of specifications shall be released to reflect the change



TAI-SAW TECHNOLOGY CO., LTD.

No. 3, Industrial 2nd Rd., Ping-Chen Industrial District,
Taoyuan, 324, Taiwan, R.O.C.

TEL: 886-3-4690038 FAX: 886-3-4697532

E-mail: tstsales@mail.taisaw.com Web: www.taisaw.com

SAW Filter 2140MHz 60MHz BW Band 1 Rx SMD 1.1×0.9 mm

MODEL NO.: TA1699D

REV. No.: 2.0

A. MAXIMUM RATING:

1. Maximum Input Power: 15 dBm
2. DC voltage: 0 V
3. Operating Temperature: -30 °C to +85 °C
4. Storage Temperature: -40 °C to +85 °C
5. Moisture Sensitivity Level: Level 3

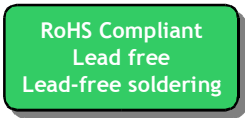

Electrostatic Sensitive Device (ESD)

B. ELECTRICAL CHARACTERISTICS:

Terminating source impedance: $Z_s = 50 \Omega$ (unbalance)

Terminating load impedance: $Z_L = 100 \Omega$ (balance)

Parameters Description (Band 1)	Unit	Minimum	Typical	Maximum
Center Frequency (Fo)	MHz	-	2140	-
Insertion Loss within 2110.0 ~ 2170.0 MHz	dB	-	2.0	2.4
Amplitude Ripple within 2110.0 ~ 2170.0 MHz	dB _{p-p}	-	0.7	1.5
VSWR within 2110.0 ~ 2170.0 MHz	-	-	1.9	2.2
Amplitude balance within 2110.0 ~ 2170.0 MHz	dB	-1.5	-0.9 ~ +0.4	+1.5
Phase balance within 2110.0 ~ 2170.0 MHz	deg	-10	-3.0 ~ +2.8	+10

Parameters Description (Band 4)	Unit	Minimum	Typical	Maximum
Center Frequency (Fo)	MHz	-	2132.0	-
Insertion Loss within 2110.0 ~ 2155.0 MHz	dB	-	1.8	2.2
Amplitude Ripple within 2110.0 ~ 2155.0 MHz	dB _{p-p}	-	0.5	1.5
VSWR within 2110.0 ~ 2155.0 MHz	-	-	1.6	2.2
Amplitude balance within 2110.0 ~ 2155.0 MHz	dB	-1.5	-0.9 ~ +0.2	+1.5
Phase balance within 2110.0 ~ 2155.0 MHz	deg	-10	-2.4 ~ +2.8	+10

Parameters Description	Unit	Minimum	Typical	Maximum
Attenuation:				
10.0 ~ 1920.0 MHz	dB	40	48	-
824.0 ~ 849.0 MHz	dB	50	58	-
1710.0 ~ 1755.0 MHz	dB	45	52	-
1920.0 ~ 1980.0 MHz	dB	50	54	-
2300.0 ~ 2500.0 MHz	dB	25	33	-
4220.0 ~ 4340.0 MHz	dB	35	51	

Notes : (1) No Matching Network .

C. FREQUENCY CHARACTERISTICS:

Frequency Response

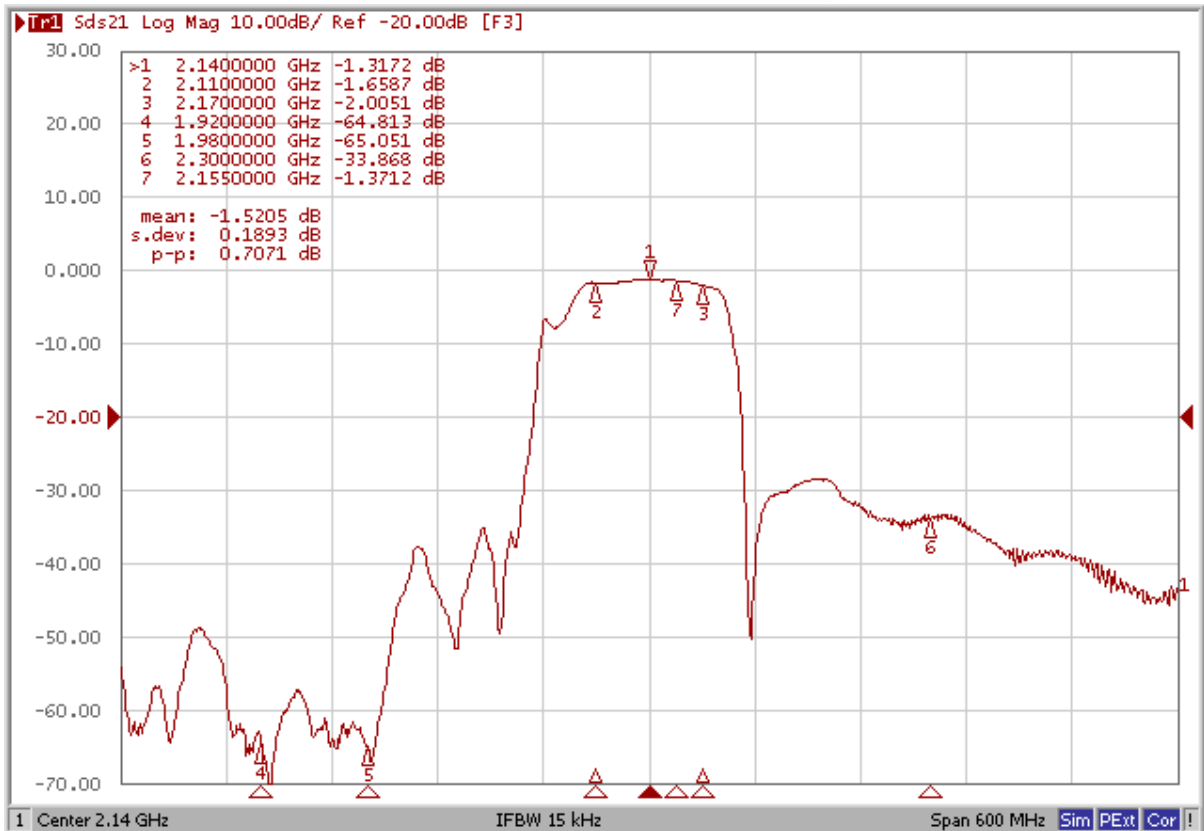

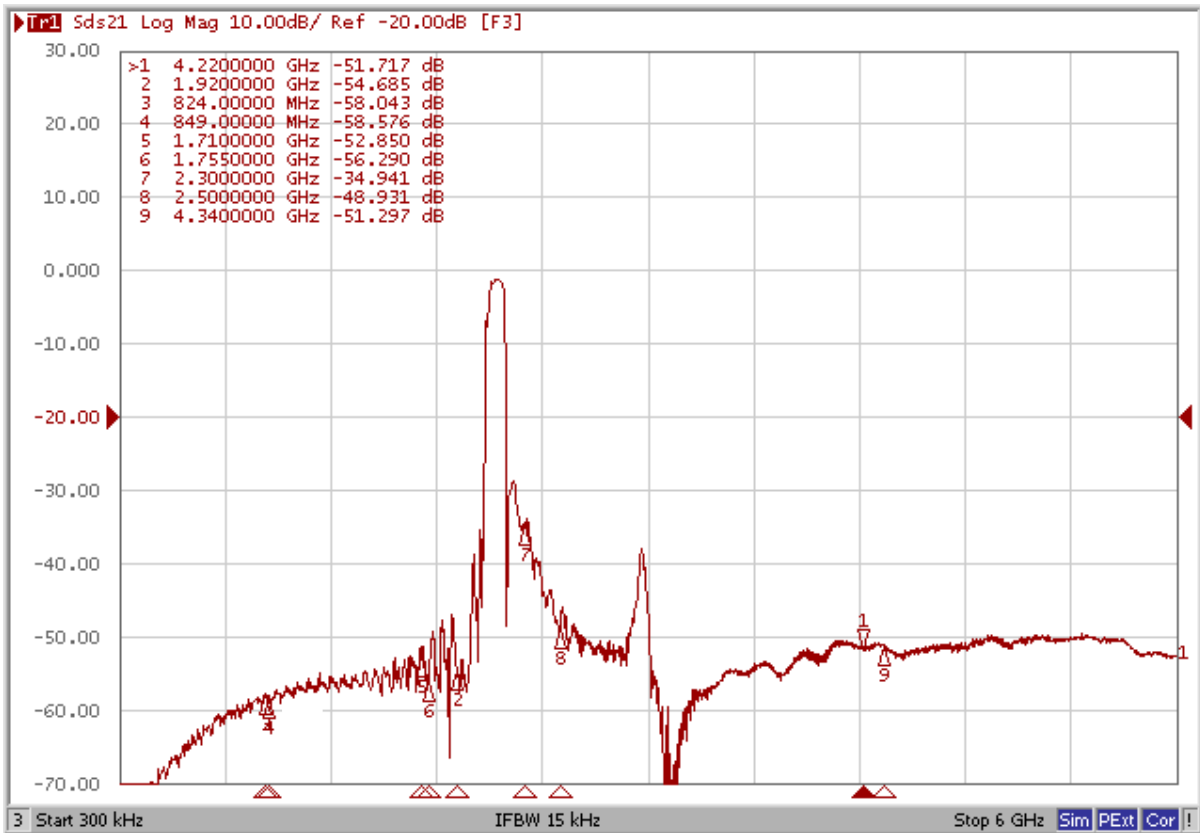

VSWR

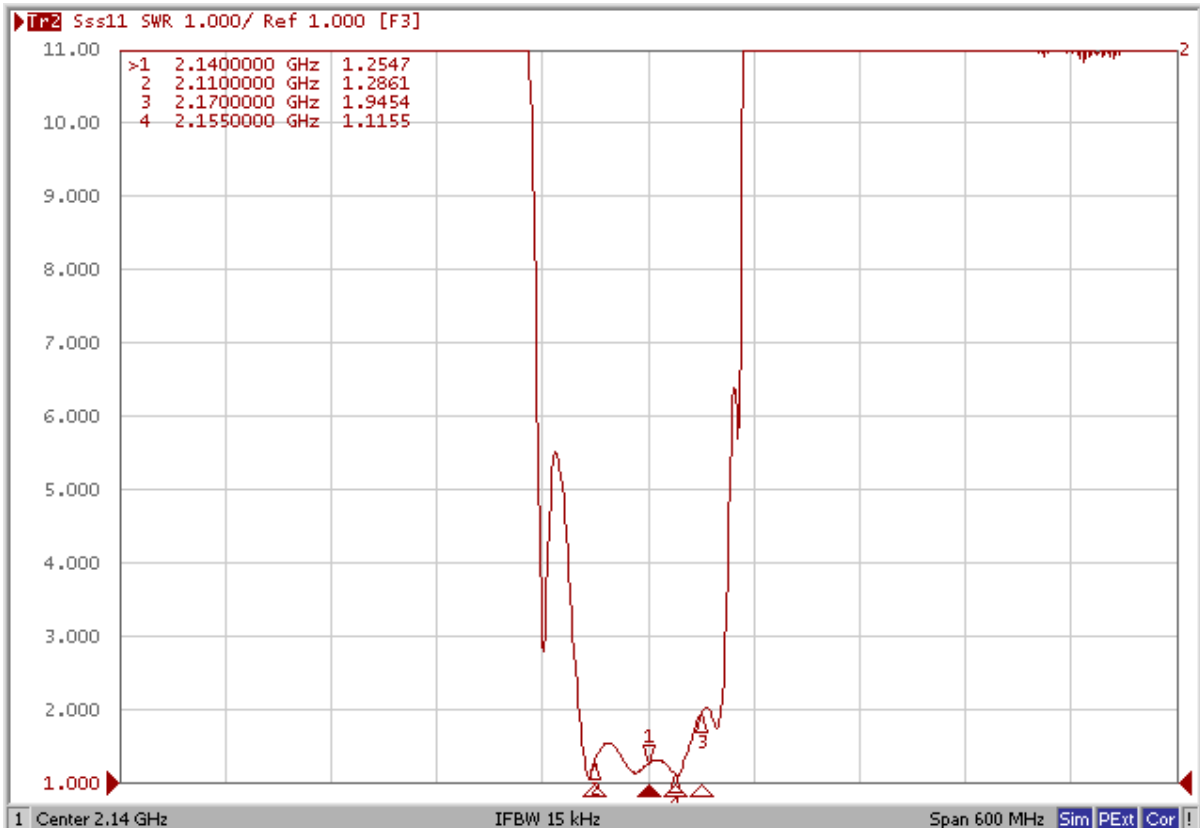

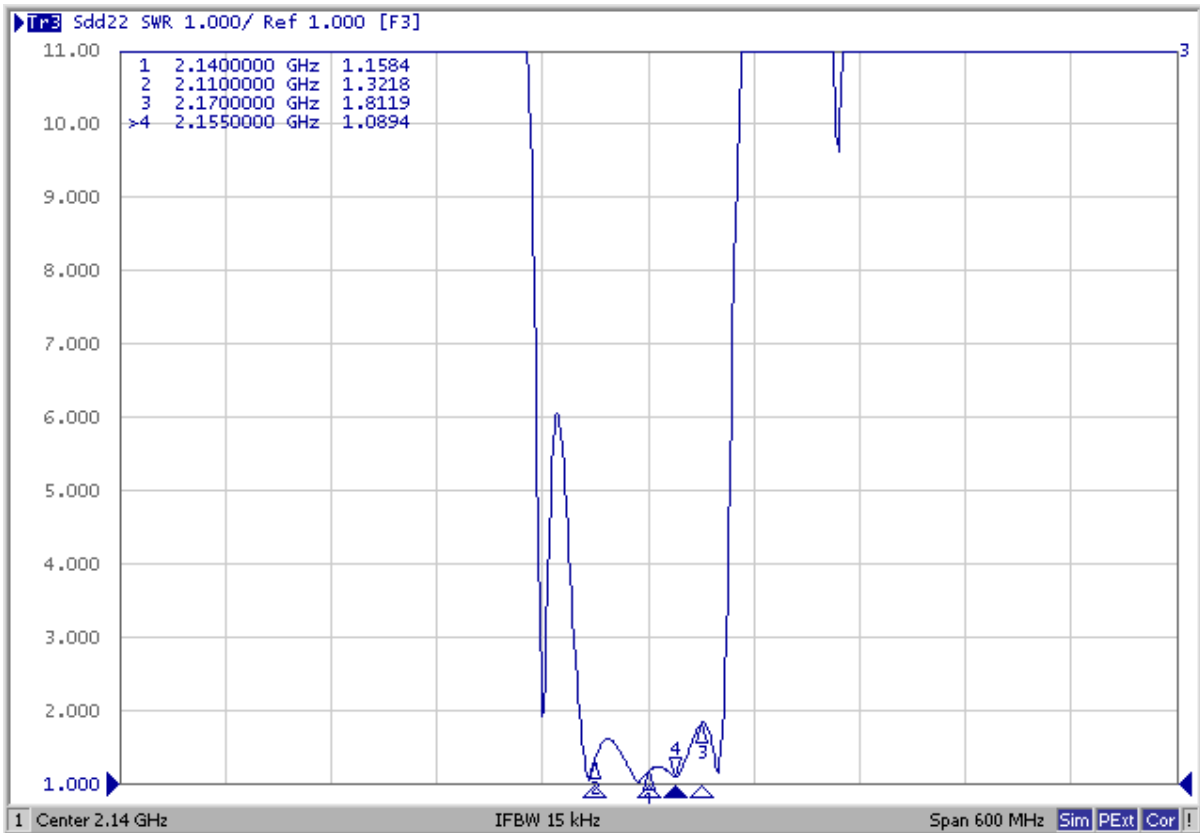

Smith Chart

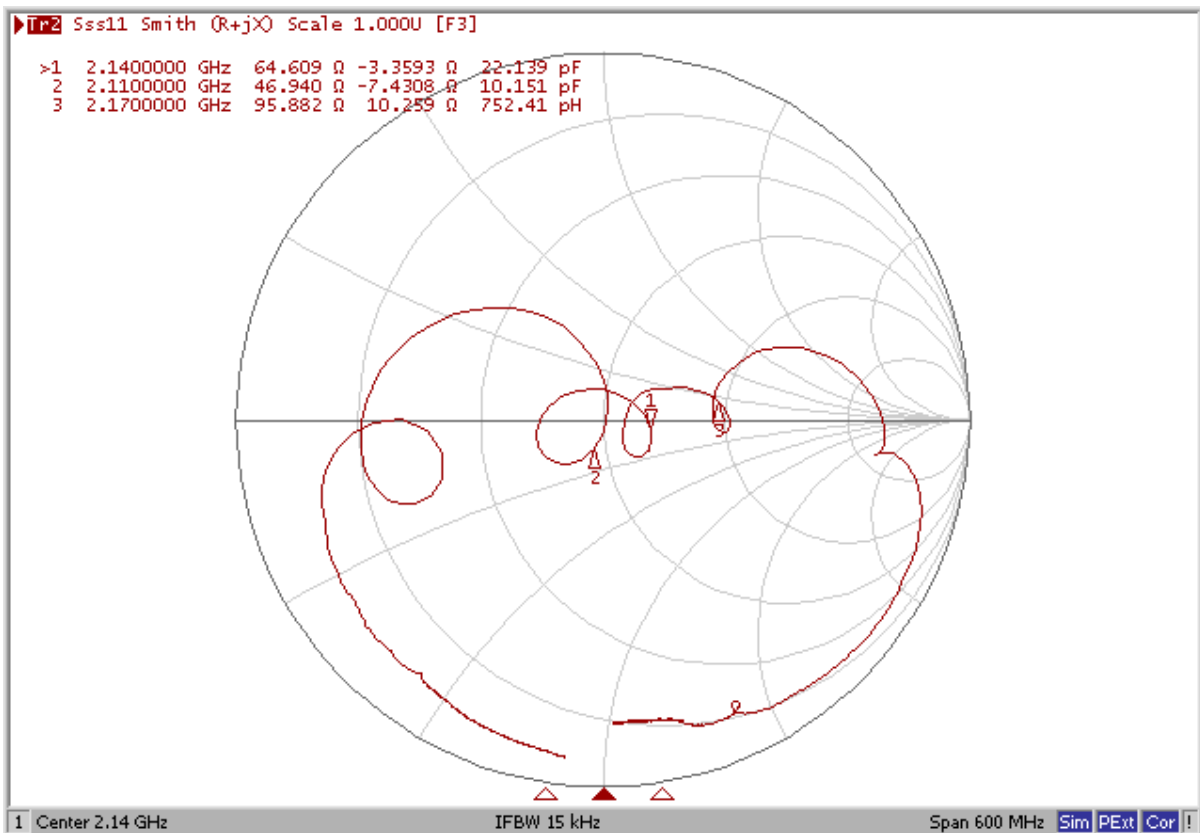

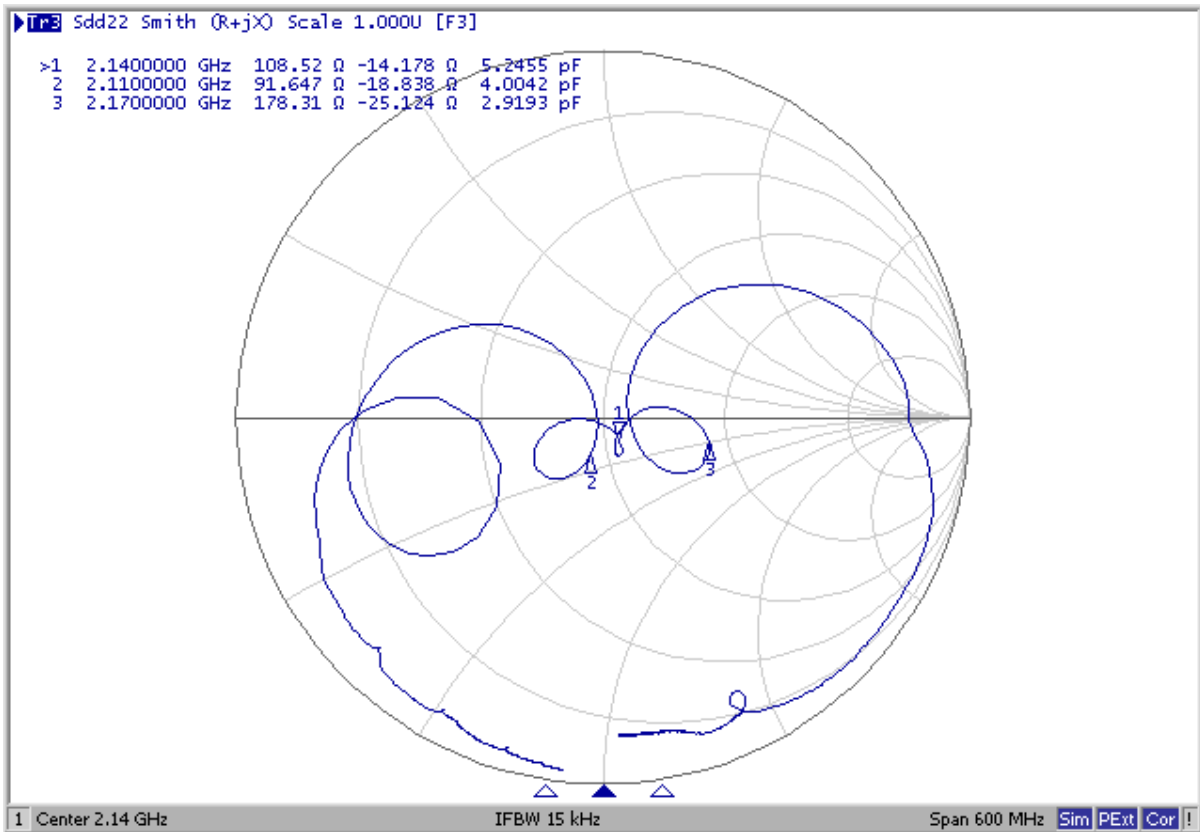

Amplitude balance

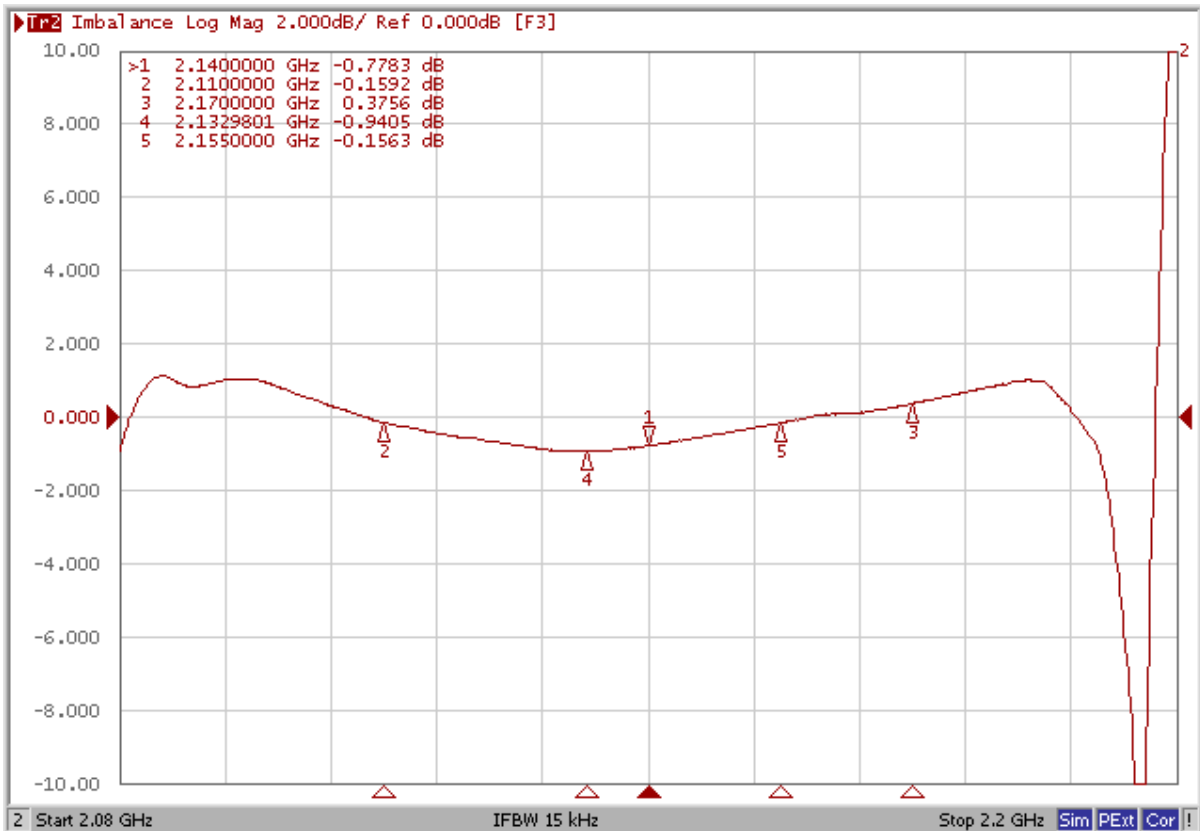

Phase balance

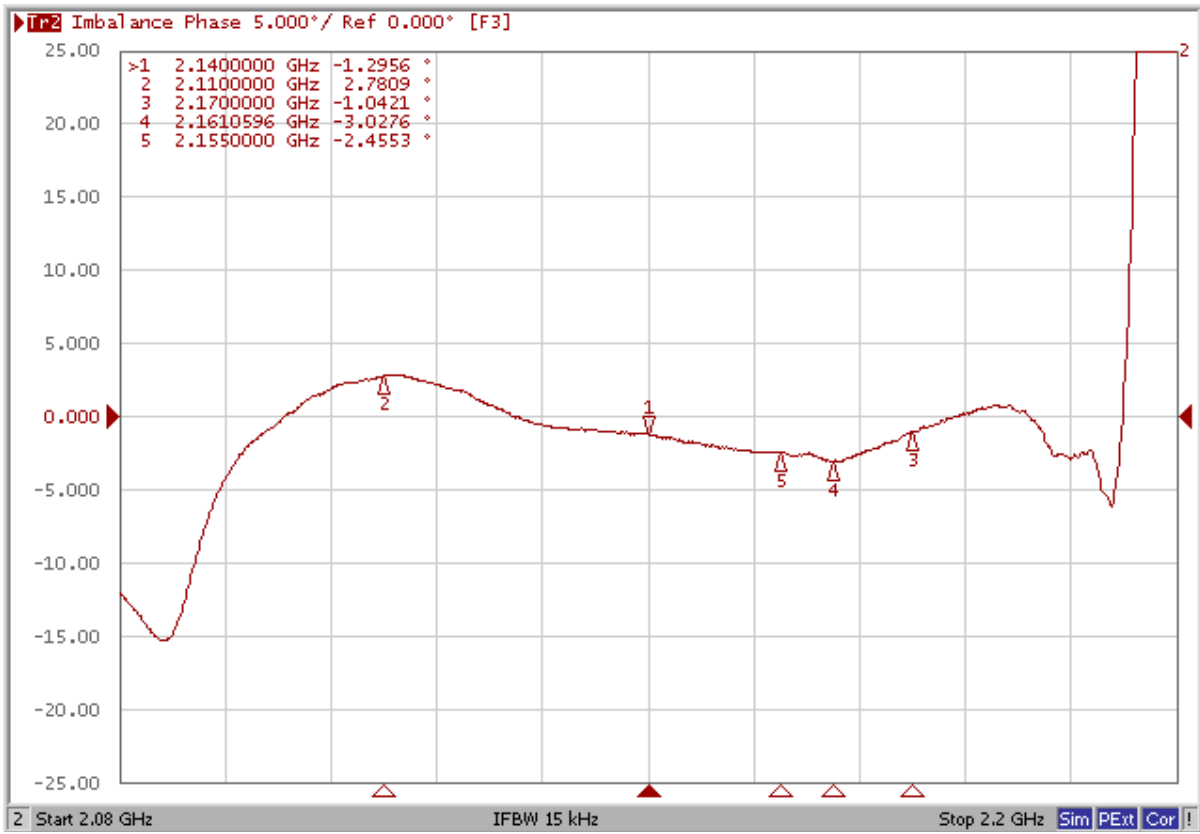

D.OUTLINE DRAWING:

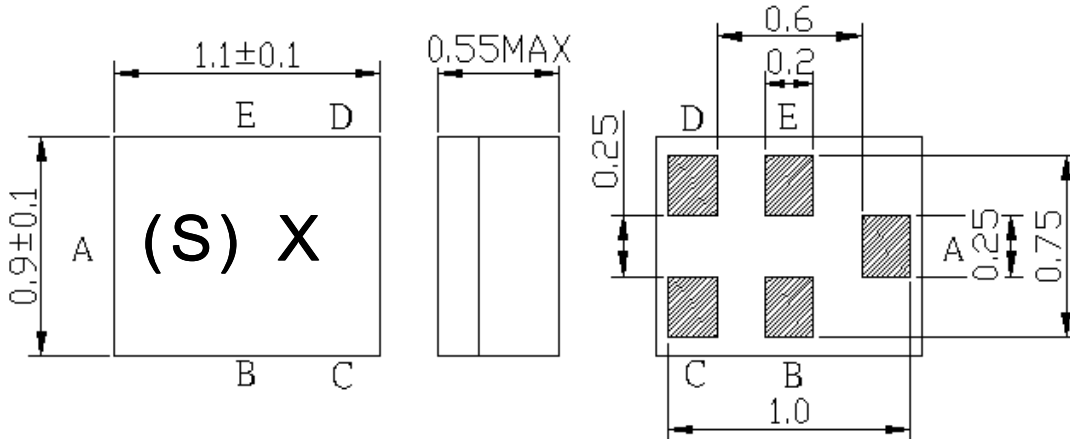

Marking Descriptions	
(S)	Series Number
X	Date Code(Year+Month)

Pin Description	
B, E	Ground
A	Input
C, D	Balanced Output

Date Code (year+month)

Year	Jan.	Feb.	Mar.	Apr.	May.	Jun.	Jul.	Aug.	Sep.	Oct.	Nov.	Dec.
2013	A	B	C	D	E	F	G	H	J	K	L	M
2014	N	P	Q	R	S	T	U	V	W	X	Y	Z
2015	a	b	c	d	e	f	g	h	j	k	l	m
2016	n	p	q	r	s	t	u	v	w	x	y	z
2017	<u>A</u>	<u>B</u>	<u>C</u>	<u>D</u>	<u>E</u>	<u>F</u>	<u>G</u>	<u>H</u>	<u>J</u>	<u>K</u>	<u>L</u>	<u>M</u>
2018	<u>N</u>	<u>P</u>	<u>Q</u>	<u>R</u>	<u>S</u>	<u>T</u>	<u>U</u>	<u>V</u>	<u>W</u>	<u>X</u>	<u>Y</u>	<u>Z</u>
2019	<u>a</u>	<u>b</u>	<u>c</u>	<u>d</u>	<u>e</u>	<u>f</u>	<u>g</u>	<u>h</u>	<u>i</u>	<u>k</u>	<u>l</u>	<u>m</u>
2020	<u>n</u>	<u>p</u>	<u>q</u>	<u>r</u>	<u>s</u>	<u>t</u>	<u>u</u>	<u>v</u>	<u>w</u>	<u>x</u>	<u>y</u>	<u>z</u>

E. MEASUREMENT CIRCUIT:

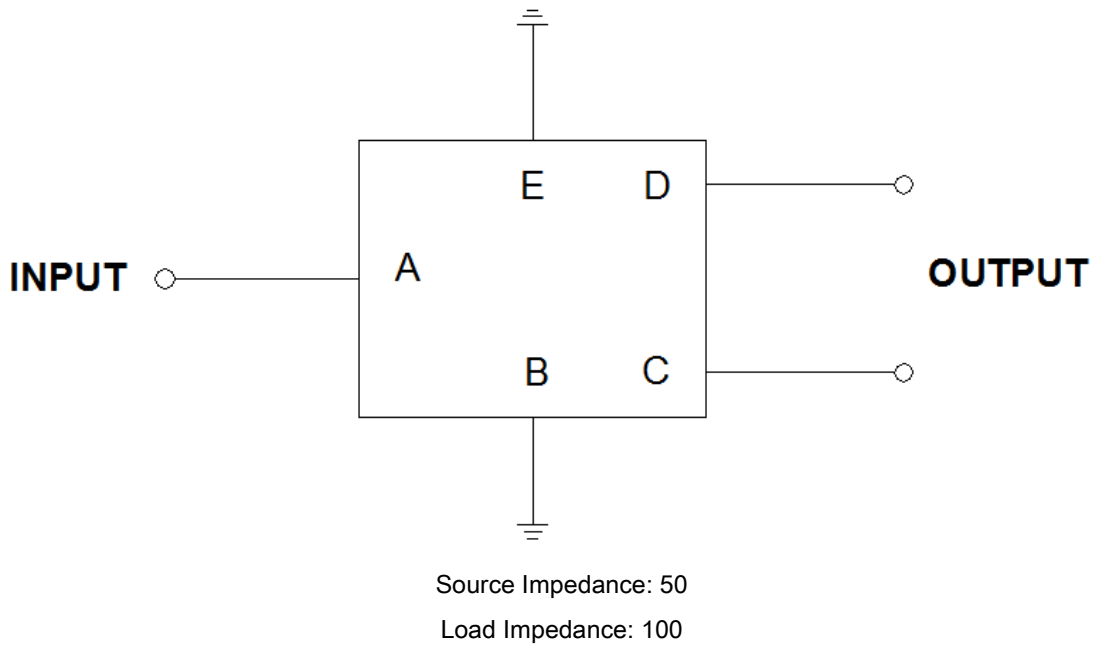

F. PCB FOOTPRINT:

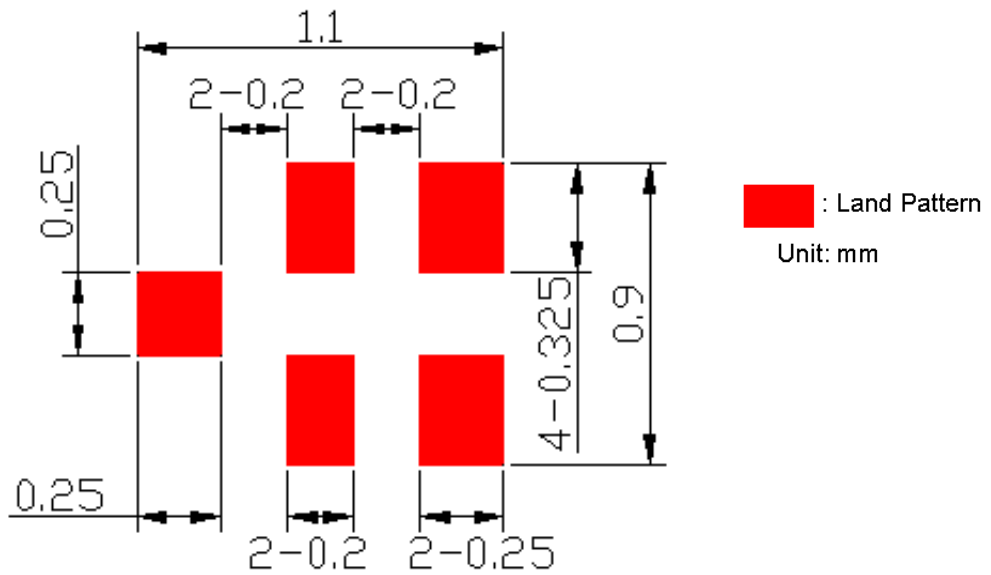

G. PACKING:

1. REEL DIMENSION

(Please refer to FR-75D10 for packing quantity)

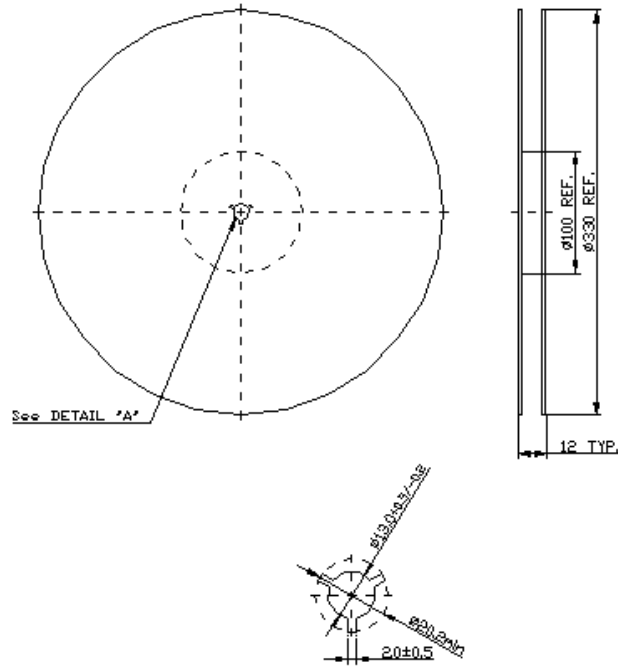

2. TAPE DIMENSION

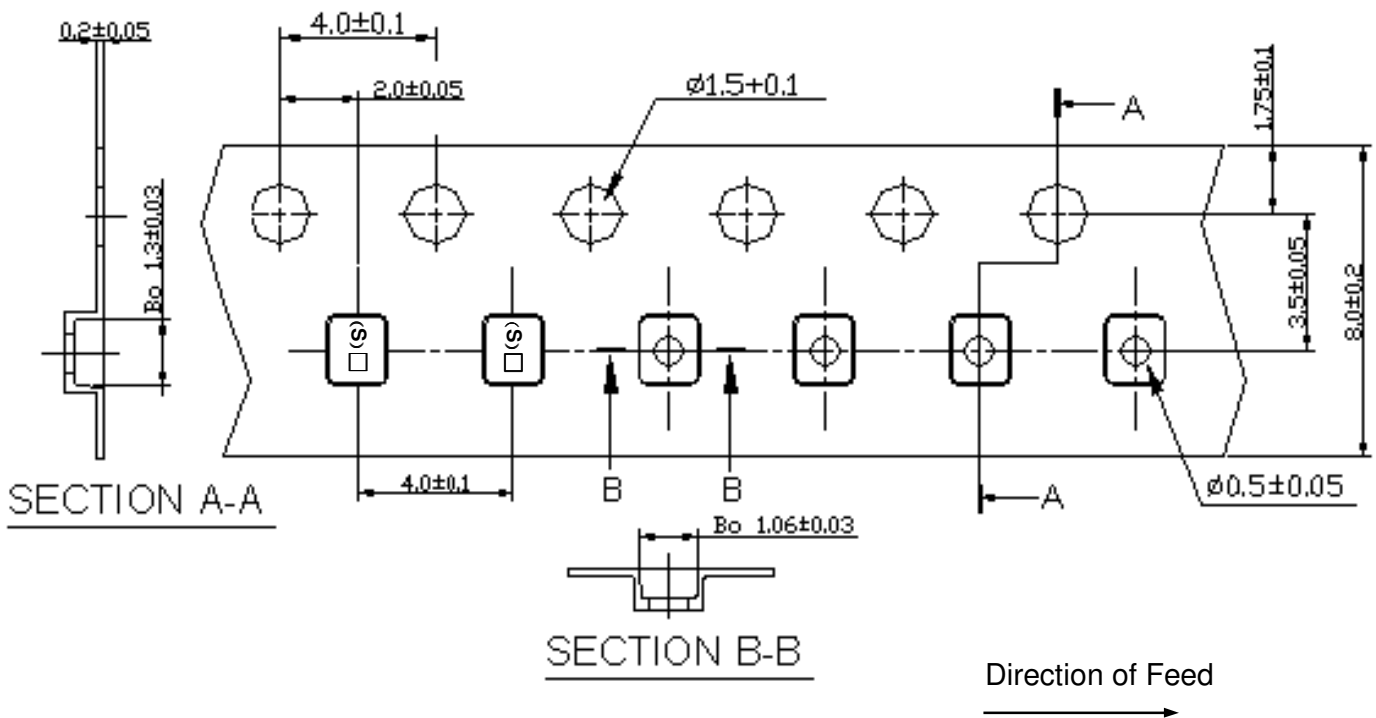

H. RECOMMENDED REFLOW PROFILE:

1. Preheating shall be fixed at 150~180°C for 60~90 seconds.
2. Ascending time to preheating temperature 150°C shall be 30 seconds min.
3. Heating shall be fixed at 220°C for 50~80 seconds and at 260°C+0/-5°C peak (20~40sec).
4. Time: 2 times.

