

SAW Filter 1592.5 MHz

MODEL NO.: TA2442A

REV. NO.:1

A. MAXIMUM RATING:

1. Input Power Level: 10 dB_m
2. DC voltage: 3 V
3. Operating Temperature: -40°C to +85°C
4. Storage Temperature: -40°C to +85°C
5. Moisture Sensitivity Level: Level 1(**MSL1**)

RoHS Compliant
Lead free
Lead-free soldering

Electrostatic Sensitive Device (ESD)

B. ELECTRICAL CHARACTERISTICS:

Item	Unit	Min.	Typ.	Max.	
Center frequency Fc	MHz	-	1592.5	-	
Insertion Loss (1560~1625 MHz) IL	dB	-	4.7	7.5	
Amplitude Ripple (1560~1625 MHz)	dB	-	2.3	5.3	
Attenuation (Reference level from 0 dB)					
1512.5 MHz	dB	30	50	-	
1672.5 MHz	dB	30	40	-	
Temperature coefficient of frequency	ppm/k	-	-36	-	

C. MEASUREMENT CIRCUIT:

HP Network analyzer

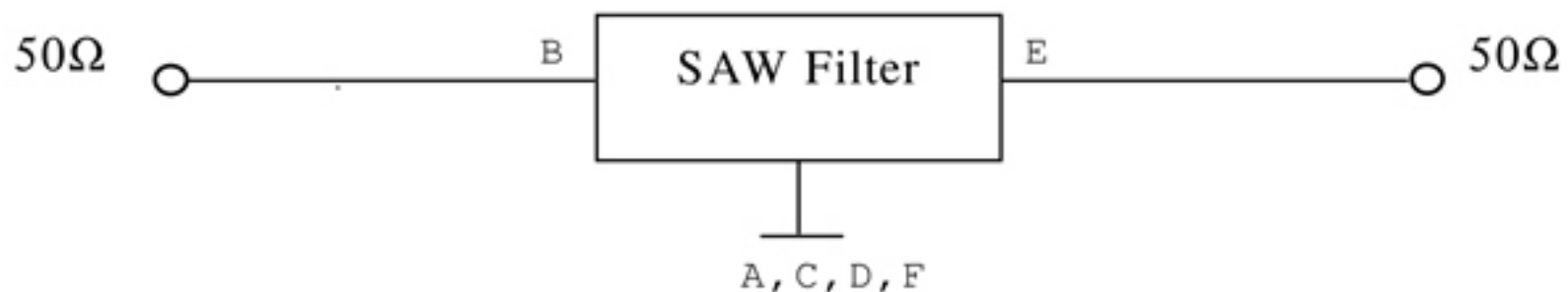

D. OUTLINE DRAWING:

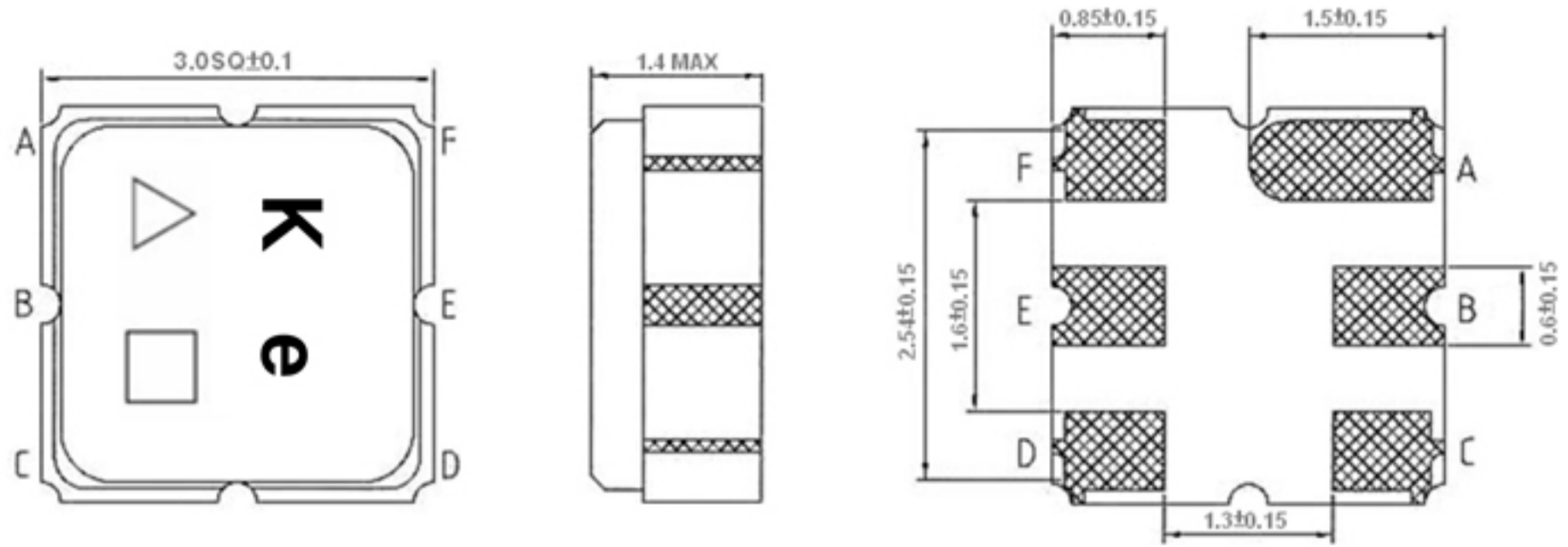

B: Input

E: Output

A, C, D, F: Ground

Unit: mm

△ : Year Code (2011->1, 2012->2, ..., 2019->9, 2020->0)

□ : Date Code

Date Code Table:

WK01	WK02	WK03	WK04	WK05	WK06	WK07	WK08	WK09	WK10	WK11	WK12	WK13
A	B	C	D	E	F	G	H	I	J	K	L	M
WK14	WK15	WK16	WK17	WK18	WK19	WK20	WK21	WK22	WK23	WK24	WK25	WK26
N	O	P	Q	R	S	T	U	V	W	X	Y	Z
WK27	WK28	WK29	WK30	WK31	WK32	WK33	WK34	WK35	WK36	WK37	WK38	WK39
a	b	c	d	e	f	g	h	i	j	k	l	m
WK40	WK41	WK42	WK43	WK44	WK45	WK46	WK47	WK48	WK49	WK50	WK51	WK52
n	o	p	q	r	s	t	u	v	w	x	y	z

E. PCB Footprint:

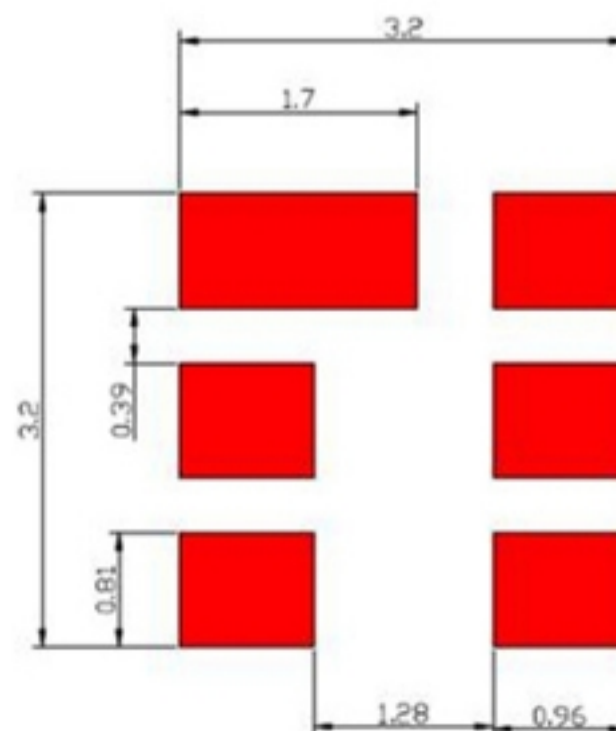

Frequency Characteristics:

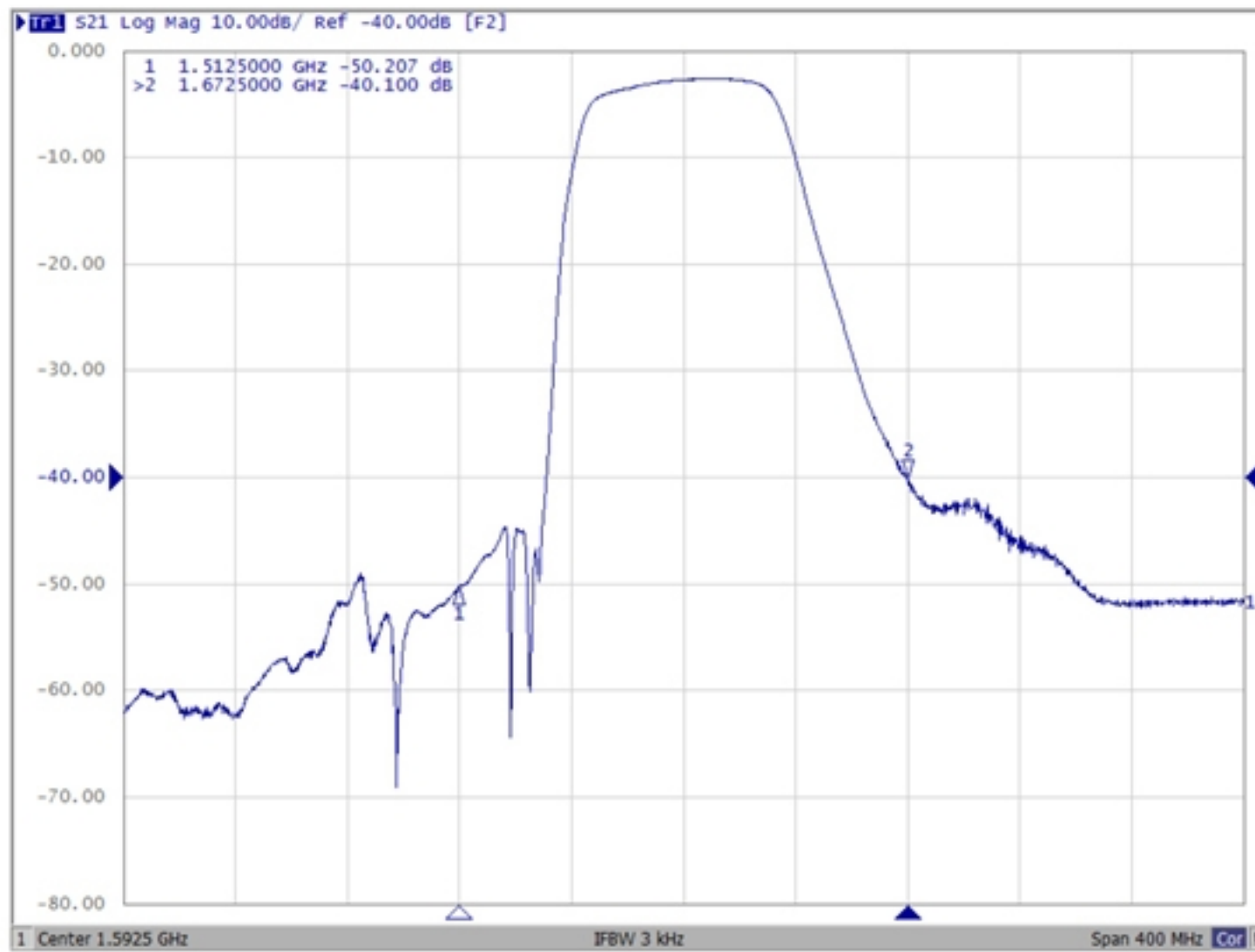
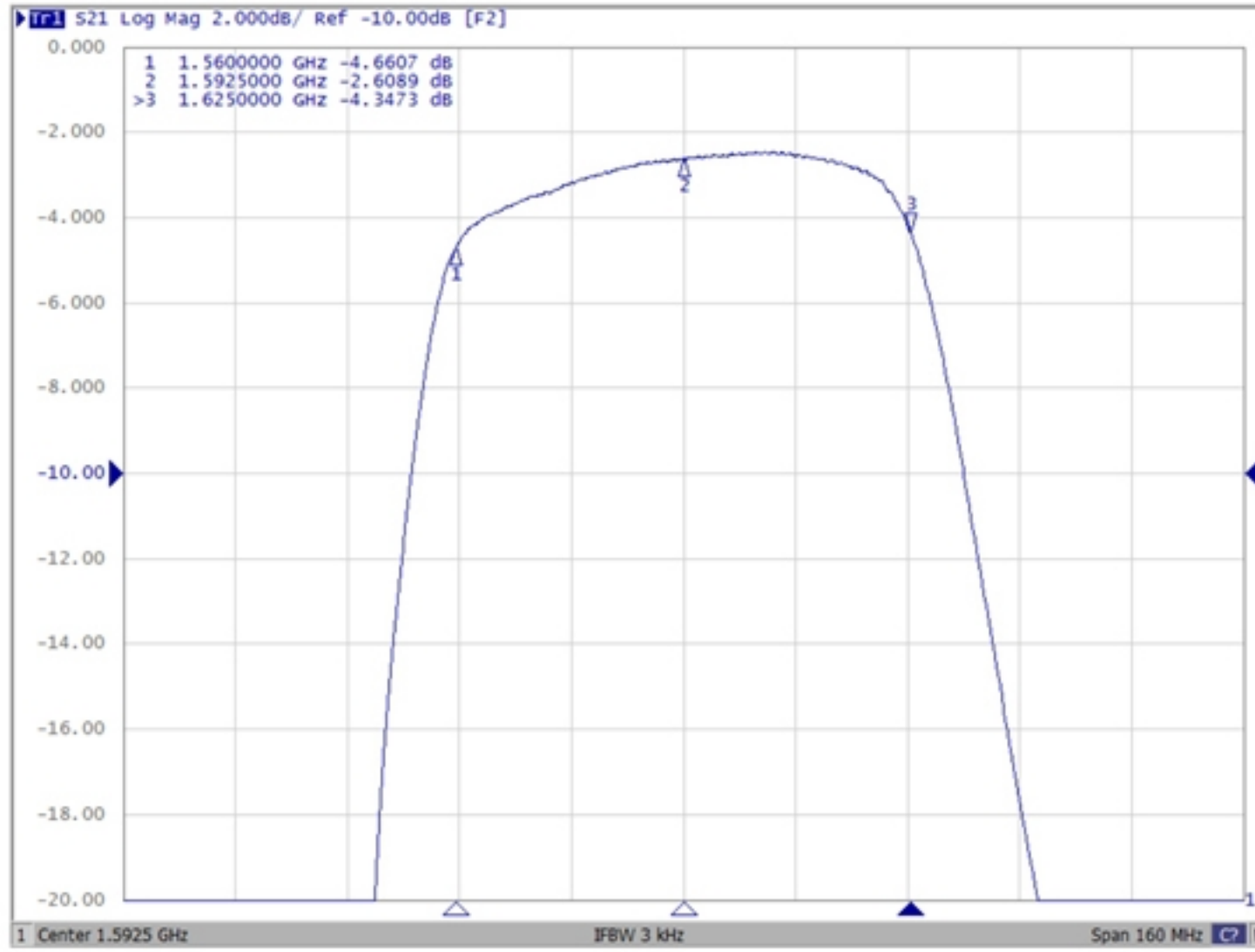

G. PACKING: (Ref. WI-75M03)

1. REEL DIMENSION

(Please refer to FR-75D10 for packing quantity)

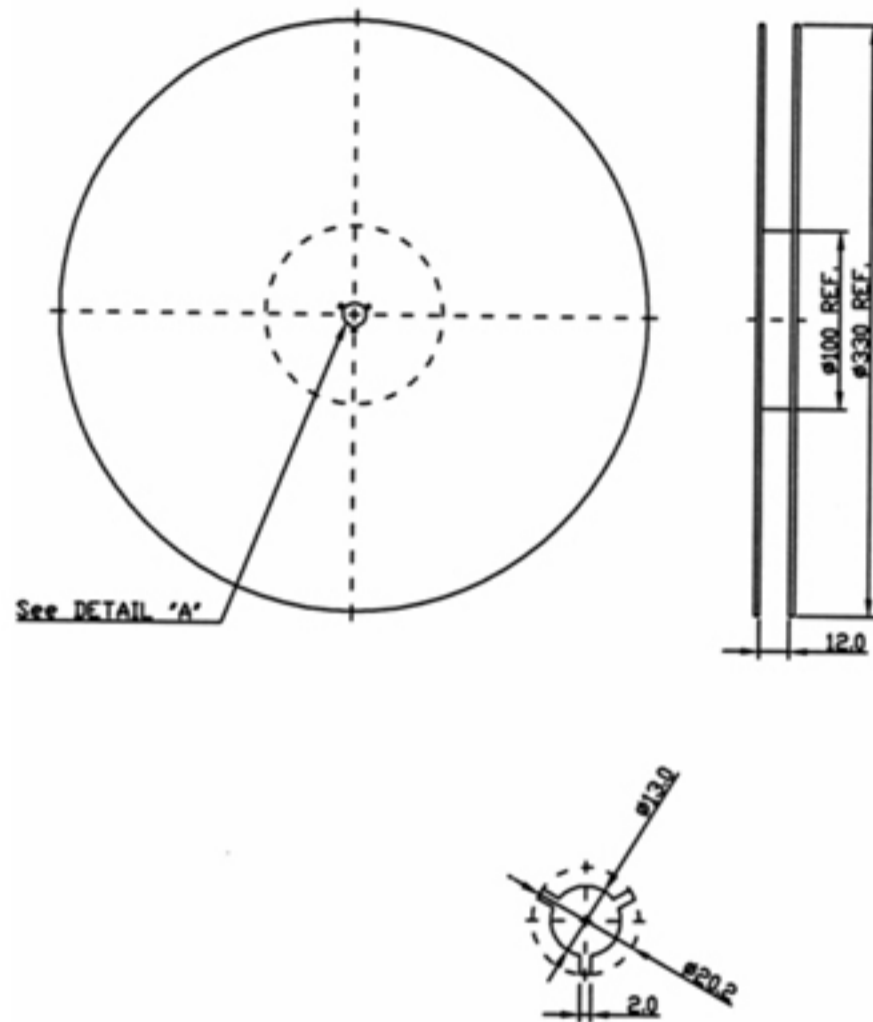

2. TAPE DIMENSION

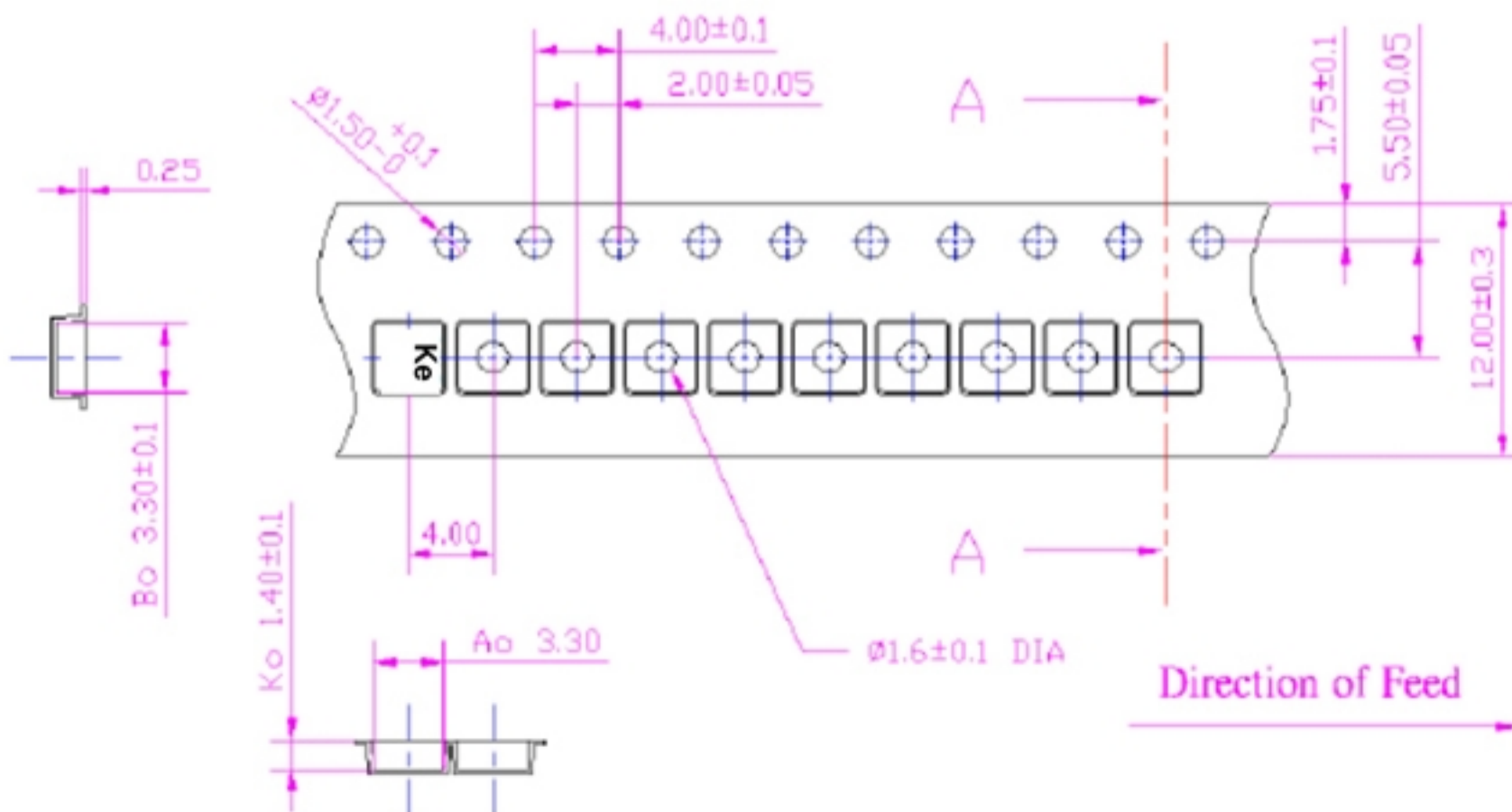

H. Recommended Reflow Profile:

1. Preheating shall be fixed at $150\sim 180^{\circ}\text{C}$ for 60~90 seconds.
2. Ascending time to preheating temperature 150°C shall be 30 seconds min.
3. Heating shall be fixed at 220°C for 50~80 seconds and at $260^{\circ}\text{C} +0/-5^{\circ}\text{C}$ peak (20~40sec).
4. Time: 2 times.

