

SAW Filter 1815 MHz (BW 50 MHz) SMD 3.0X3.0 mm

MODEL NO.:TA2561A

REV. NO.:1.0

A. MAXIMUM RATING:

1. Input Power Level: 15 dBm
2. DC Voltage : 0 V
3. Operating Temperature: -45 °C to +85 °C
4. Storage Temperature: -45 °C to +85 °C

RoHS Compliant
Lead free
Lead-free soldering

Electrostatic Sensitive Device (ESD)

B. ELECTRICAL CHARACTERISTICS:

Terminating source impedance (single) : $Z_s = 50 \Omega$

Terminating load impedance(single) : $Z_L = 50 \Omega$

Item	Unit	Min	Typ.	Max
Center Frequency	MHz	-	1815	-
Insertion Loss (1790~1840 MHz)	dB	-	2.7	3.5
Insertion Loss (1780~1850 MHz)	dB	-	3.8	5.5
Attenuation (Reference from 0 dB)				
10 ~ 1750 MHz	dB	27	30	-
1750 ~ 1770 MHz	dB	5	18	-
1870 ~ 1930 MHz	dB	10	23	-
1930 ~ 3000 MHz	dB	30	35	-
Temperature Coefficient of Frequency	ppm/K	-	-36	-

C. TEST CIRCUIT:

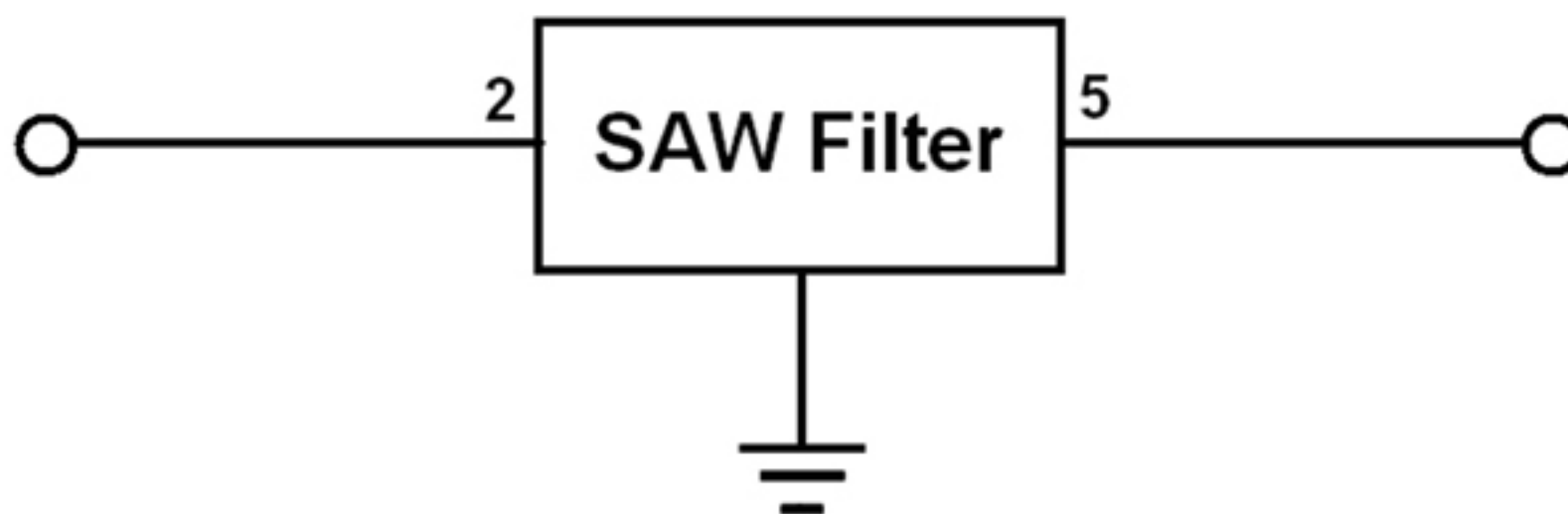

D. OUTLINE DRAWING:

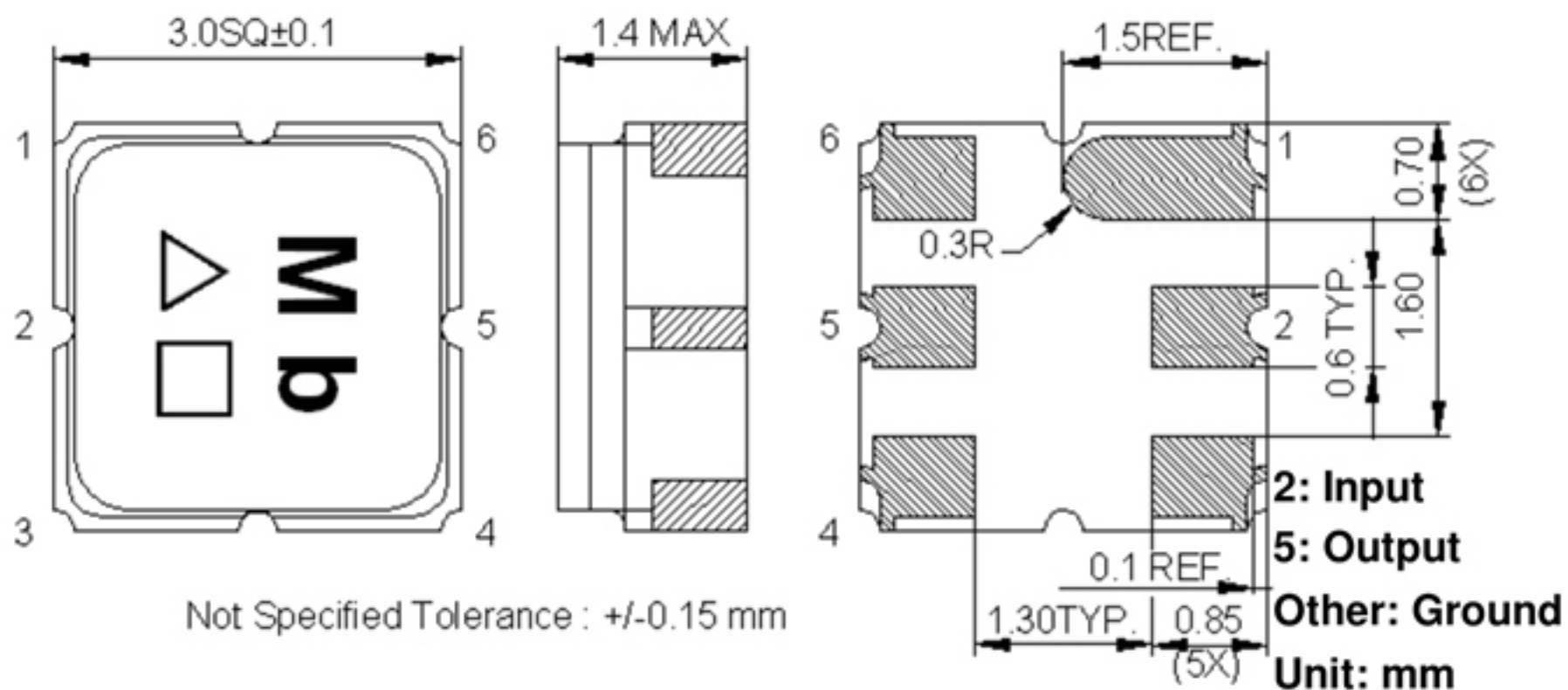

△ : Year Code (2009->9, 2010->0, ..., 2018->8)

□ : Date Code (Follow the table from planner each year)

WK01	WK02	WK03	WK04	WK05	WK06	WK07	WK08	WK09	WK10	WK11	WK12	WK13
A	B	C	D	E	F	G	H	I	J	K	L	M
WK14	WK15	WK16	WK17	WK18	WK19	WK20	WK21	WK22	WK23	WK24	WK25	WK26
N	O	P	Q	R	S	T	U	V	W	X	Y	Z
WK27	WK28	WK29	WK30	WK31	WK32	WK33	WK34	WK35	WK36	WK37	WK38	WK39
a	b	c	d	e	f	g	h	i	j	k	l	m
WK40	WK41	WK42	WK43	WK44	WK45	WK46	WK47	WK48	WK49	WK50	WK51	WK52
n	o	p	q	r	s	t	u	v	w	x	y	z

E. Frequency Characteristics:

Span 800 MHz

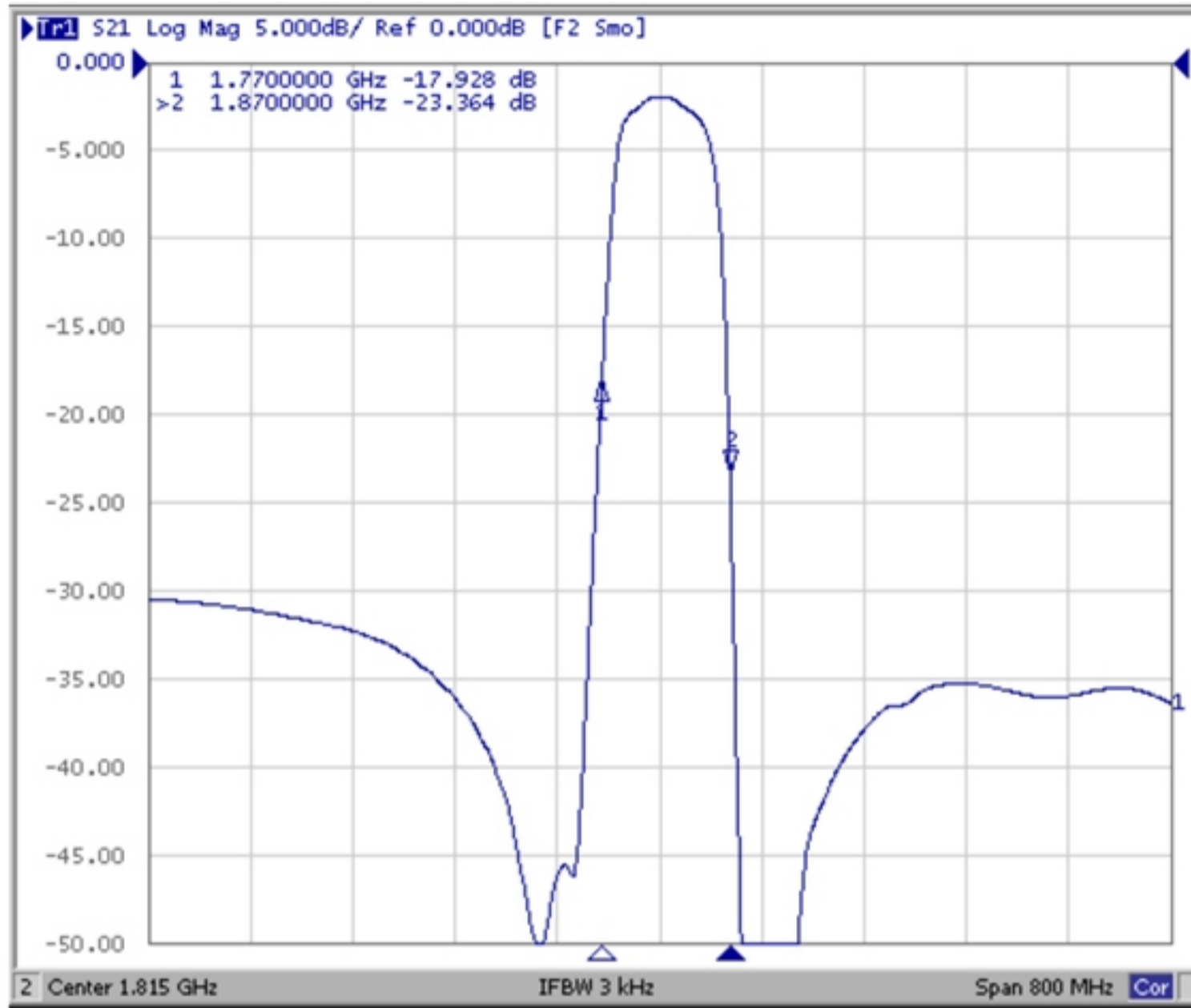

Span 3000 MHz

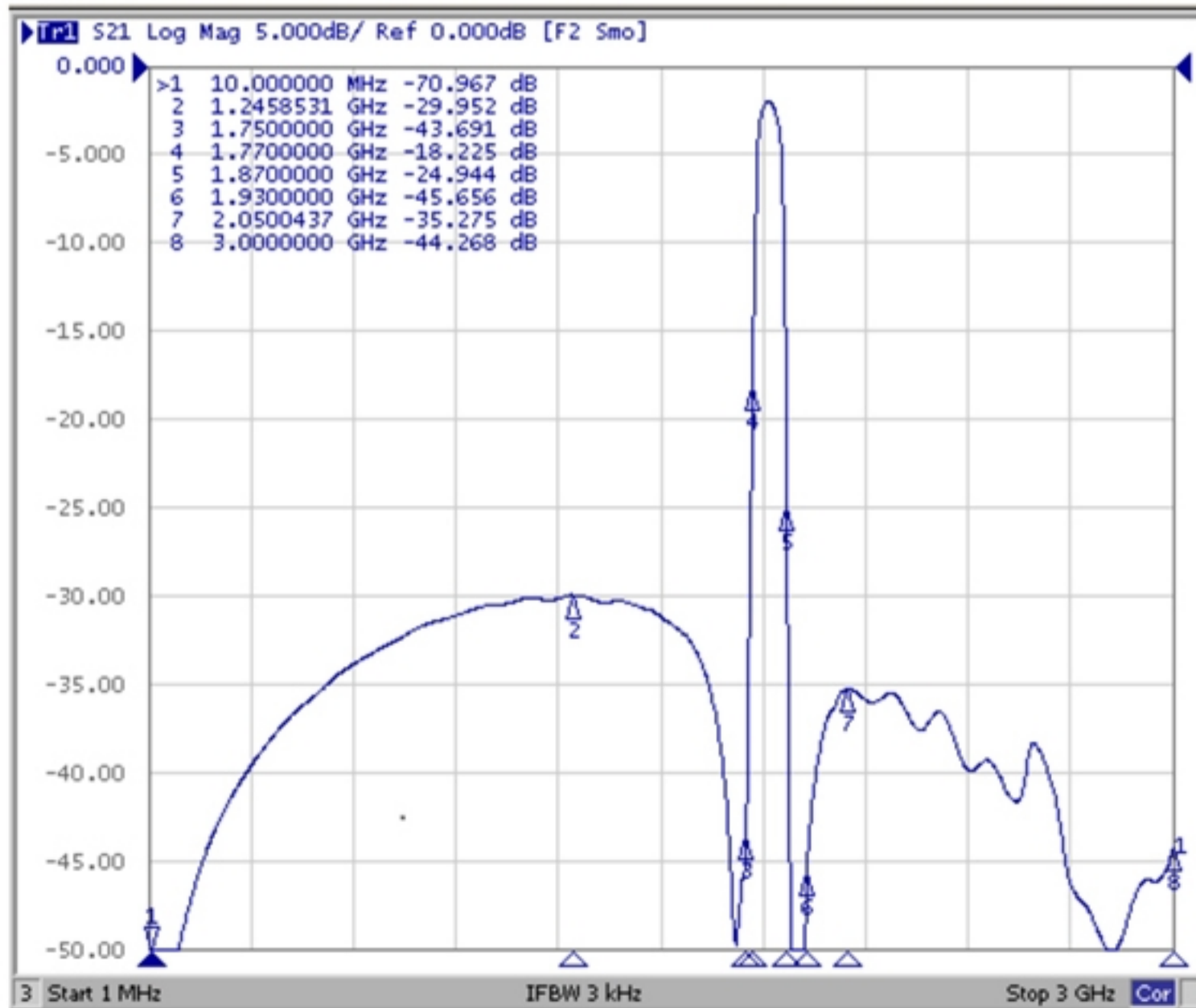

Span 100 MHz

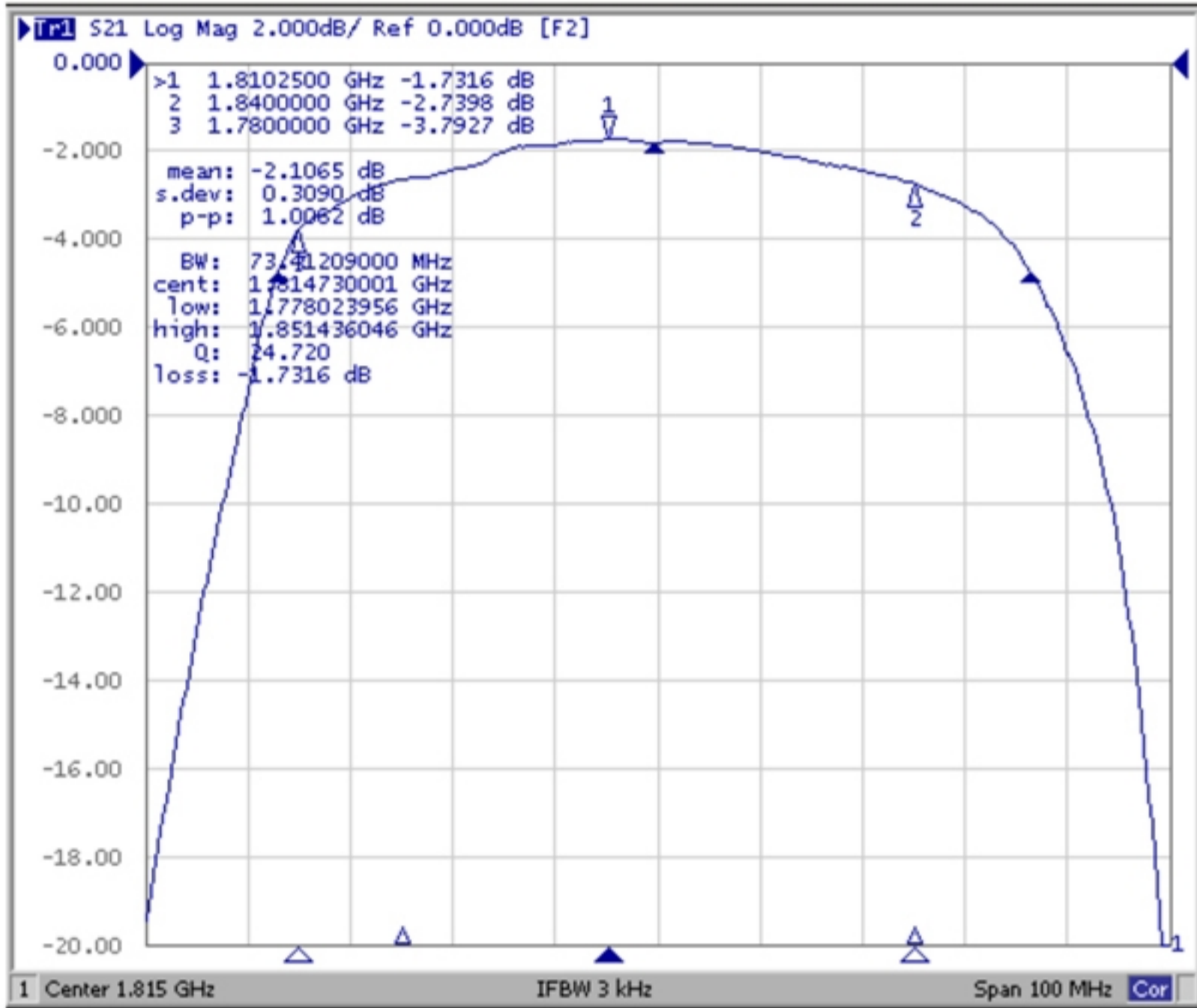

Reflection Characteristic

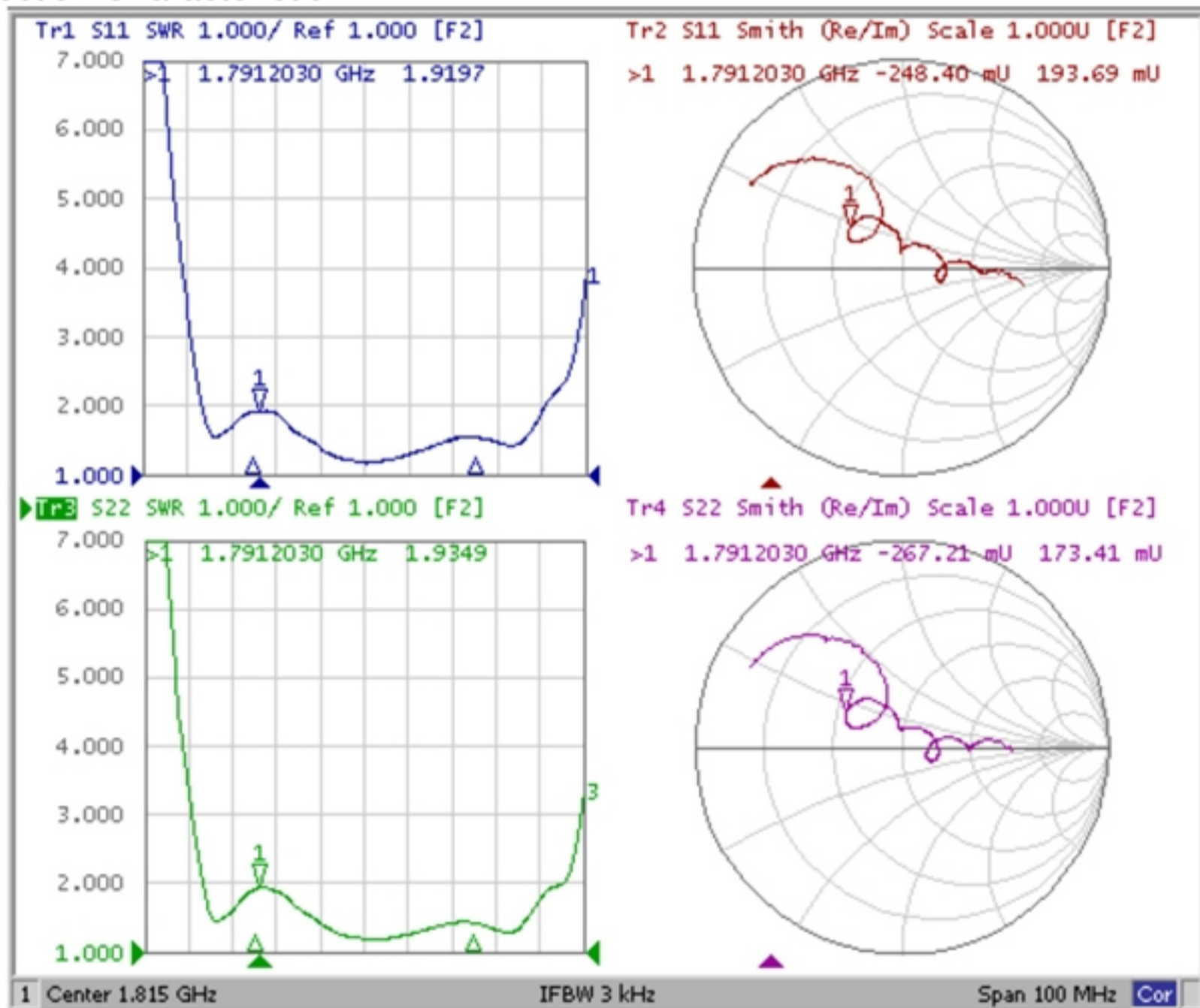

F. PCB FOOTPRINT:

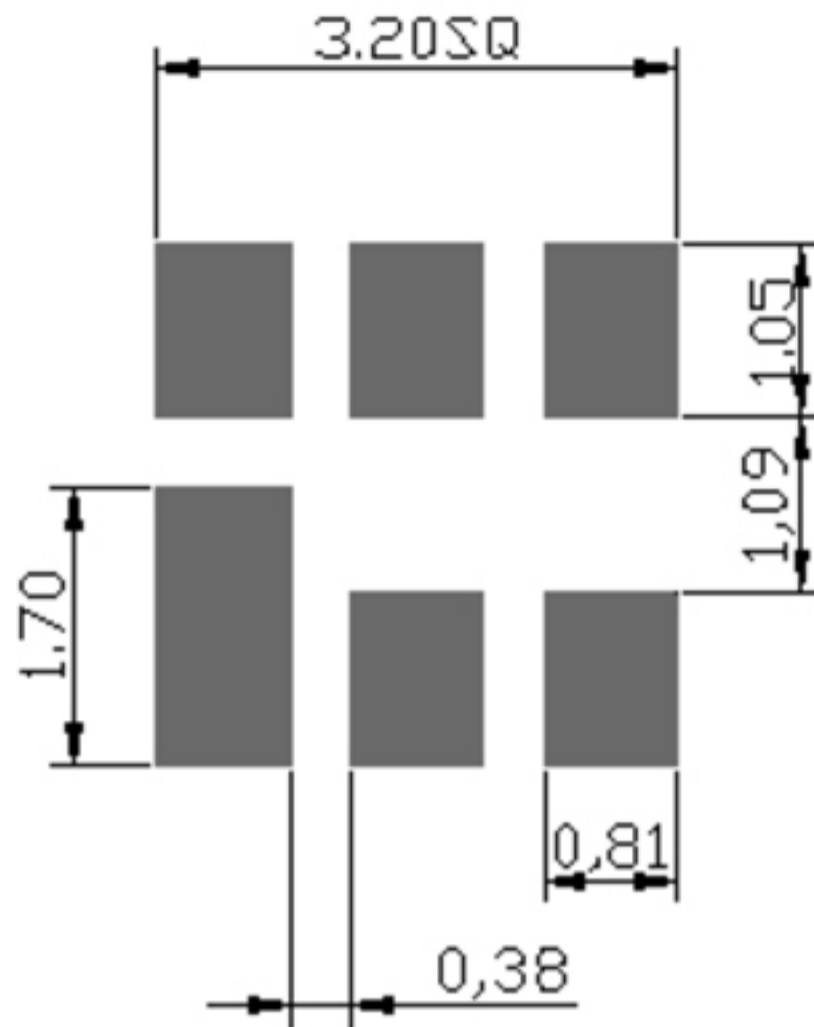

G. PACKING:

1. REEL DIMENSION

(Please refer to FR-75D10 for packing quantity)

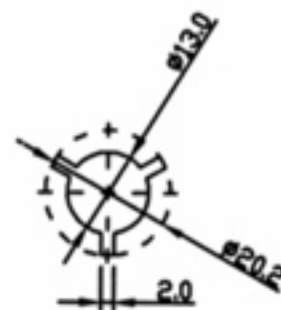
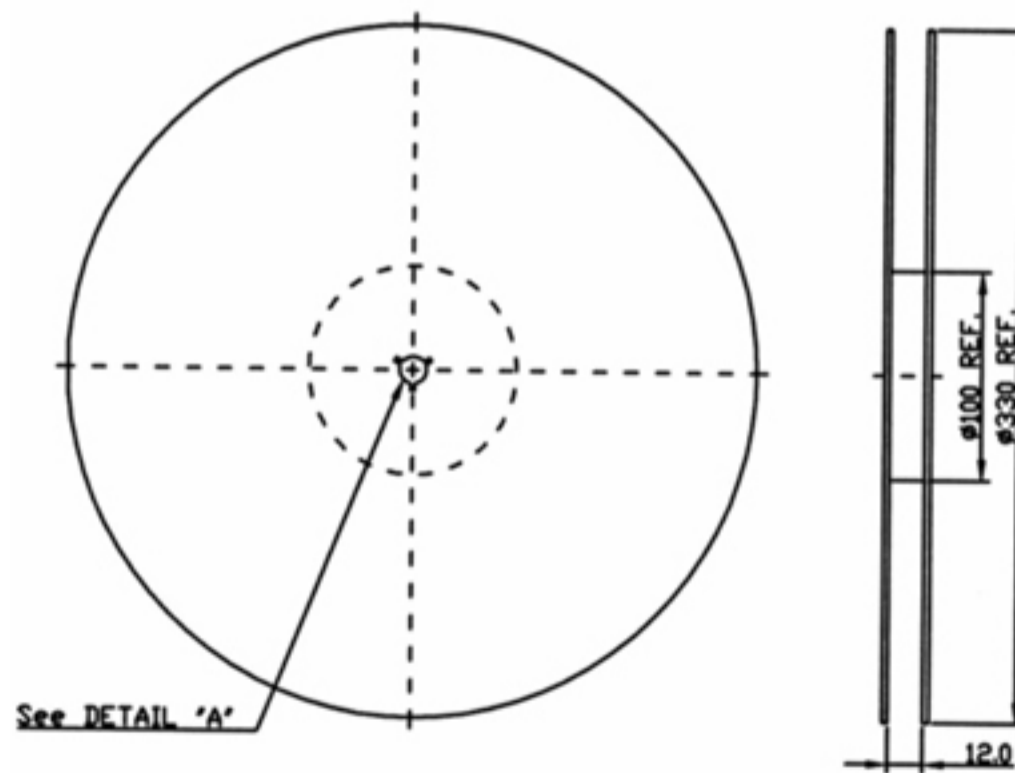

2. TAPE DIMENSION

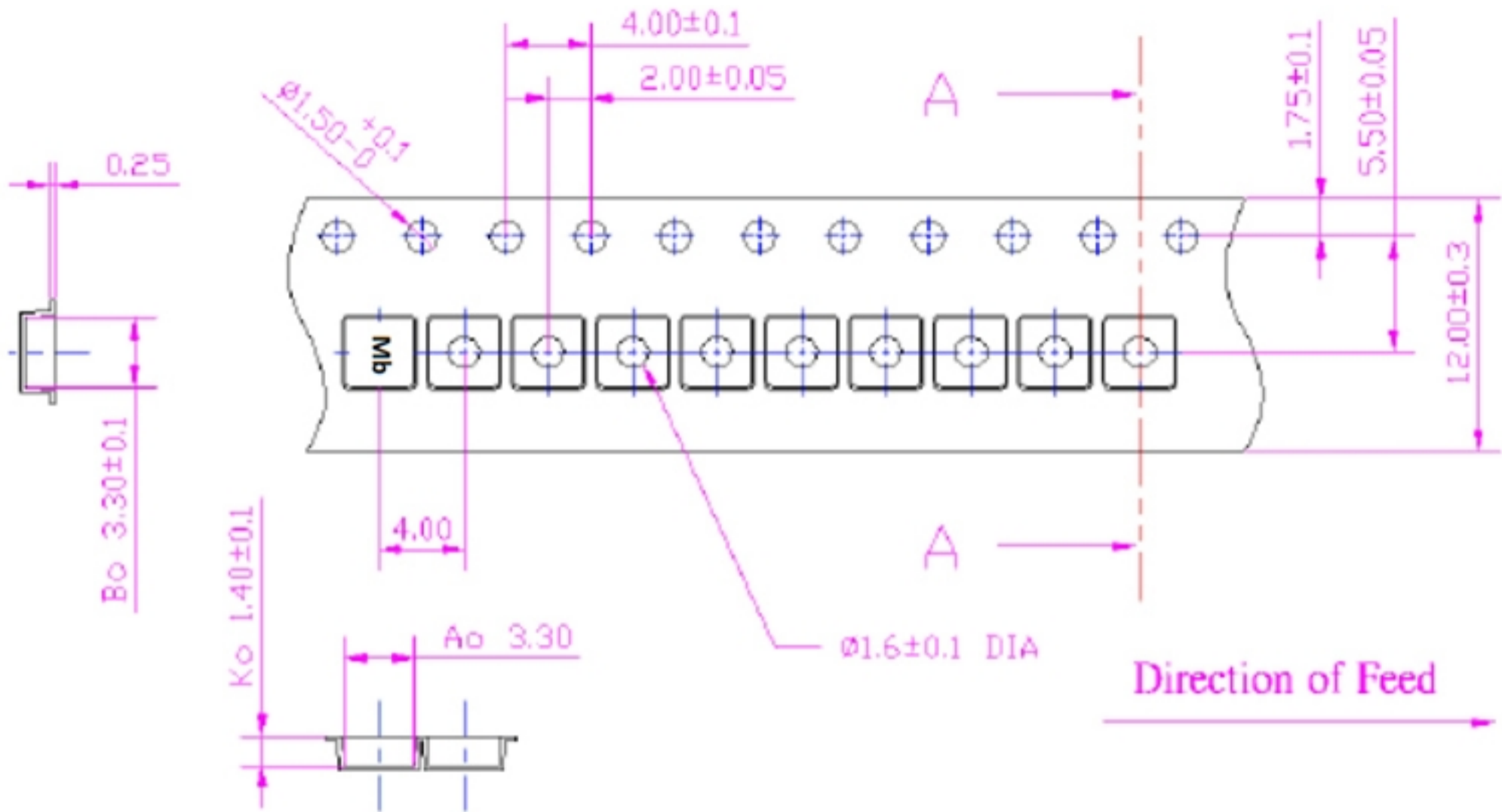

H. RECOMMENDED REFLOW PROFILE :

1. Preheating shall be fixed at $150 \sim 180^{\circ}\text{C}$ for $60 \sim 90$ seconds.
2. Ascending time to preheating temperature 150°C shall be 30 seconds min.
3. Heating shall be fixed at 220°C for $50 \sim 80$ seconds and at $260^{\circ}\text{C} + 0/-5^{\circ}\text{C}$ peak ($20 \sim 40$ sec).
4. Time: 2 times.

