



TAI-SAW TECHNOLOGY CO., LTD.

No. 3, Industrial 2nd Rd., Ping-Chen Industrial District,
Taoyuan, 324, Taiwan, R.O.C.

TEL: 886-3-4690038 FAX: 886-3-4697532

E-mail: tstsales@mail.taisaw.com Web: www.taisaw.com

Product Specifications Approval Sheet

Product Description: SAW Tx Filter 2350MHz LTE Band 40 SMD 1109

TST Part No.: TA1966A

Customer Part No.:

Customer signature required
Company: _____
Division: _____
Approved by : _____
Date: _____

Checked by: _____ Anne Chen *Anne Chen*

Approved by: _____ Andy Yu *Andy Yu*

Date: _____ 2018/02/26

1. Customer signed back is required before TST can proceed with sample build and receive orders.
2. Orders received without customer signed back will be regarded as agreement on the specifications.
3. Any specifications changes must be approved upon by both parties and a new revision of specifications shall be released to reflect the changes.



TAI-SAW TECHNOLOGY CO., LTD.

No. 3, Industrial 2nd Rd., Ping-Chen Industrial District,
Taoyuan, 324, Taiwan, R.O.C.

TEL: 886-3-4690038 FAX: 886-3-4697532

E-mail: tstsales@mail.taisaw.com Web: www.taisaw.com

SAW Tx Filter 2350MHz LTE Band 40 SMD 1109 (100MHz BW)

MODEL NO.:TA1966A

REV. NO.:3

A. MAXIMUM RATING:

1. Input Power Level: 28dBm
2. DC Voltage : 0V
3. Operating Temperature: -30°C to +85°C
4. Storage Temperature: -40°C to +85°C
5. Moisture Sensitivity Level: Level 3
6. ESD 50V(MM) 100V(HBM)

RoHS Compliant
Lead free
Lead-free soldering

Electrostatic Sensitive Device (ESD)

B. ELECTRICAL CHARACTERISTICS:

Terminating source impedance : $Z_s = 50 \Omega$

Terminating load impedance : $Z_L = 50 \Omega$

Item	Unit	Min.	Typ.	Max.	Note
Center Frequency Fc	MHz	-	2350	-	-
Insertion Loss (2300~2400 MHz)	dB	-	1.9	2.8	-
Amplitude ripple (2300~2400 MHz)	dBp-p	-	1.2	2.3	-
VSWR (2300~2400 MHz)		-	1.5	2.0	-
Attenuation (reference level from 0 dB)					
10 ~ 1574 MHz	dB	20	29	-	-
1574 ~ 1577 MHz	dB	20	29		
1577 ~ 1680 MHz	dB	20	27		
1845 ~ 1880 MHz	dB	18	25	-	-
2110 ~ 2170 MHz	dB	18	25	-	-
2240 ~ 2285 MHz	dB	1.5	7	-	-
2415 ~ 2420 MHz	dB	1.5	5	-	-
2420 ~ 2460 MHz	dB	3	6	-	-
2460 ~ 2485 MHz	dB	30	43	-	-
2485 ~ 2500 MHz	dB	30	48		
2500 ~ 3000 MHz	dB	20	26		
4600 ~ 4800 MHz	dB	20	25		
4800 ~ 6000 MHz	dB	18	21		
Temperature Coefficient of Frequency	ppm/°C	-	-36	-	-

C. OUTLINE DRAWING:

top view

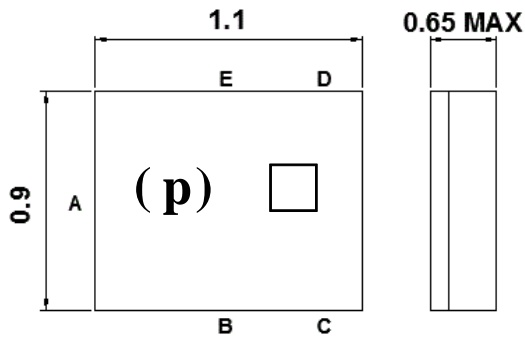

bottom view

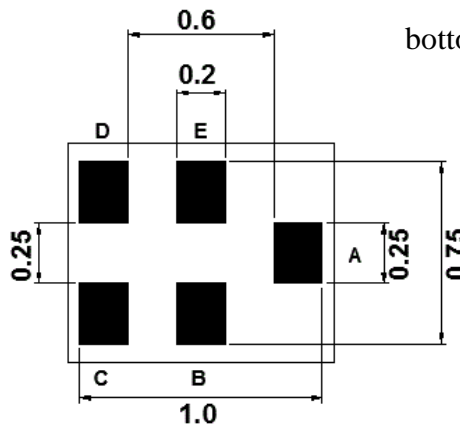

Marking Descriptions	
(p)	Series Number
□	Date Code(Year+Month)

Pin Description	
B, C, E	Ground
A	Input
D	Output

□ : Year/Month Code (Follow the table)

Date Code Table:

	Jan.	Feb.	Mar.	Apr.	May	Jun.	July	Aug.	Sep.	Oct.	Nov.	Dec.
2015	a	b	c	d	e	f	g	h	j	k	l	m
2016	n	p	q	r	s	t	u	v	w	x	y	z
2017	<u>A</u>	<u>B</u>	<u>C</u>	<u>D</u>	<u>E</u>	<u>F</u>	<u>G</u>	<u>H</u>	<u>J</u>	<u>K</u>	<u>L</u>	<u>M</u>
2018	<u>N</u>	<u>P</u>	<u>Q</u>	<u>R</u>	<u>S</u>	<u>I</u>	<u>U</u>	<u>V</u>	<u>W</u>	<u>X</u>	<u>Y</u>	<u>Z</u>

D. MEASUREMENT CIRCUIT:

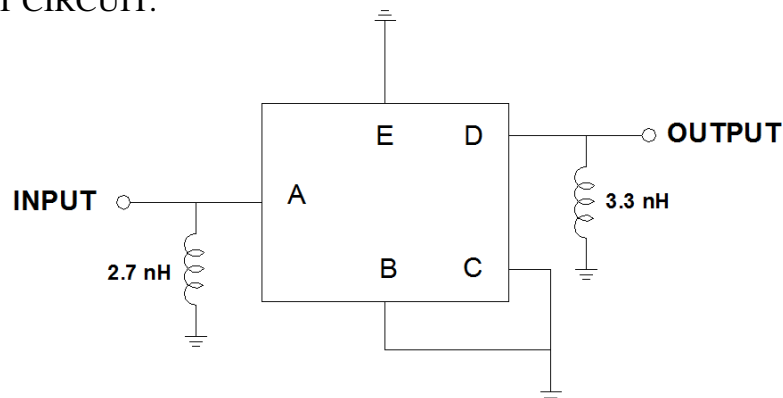

E. PCB Footprint :

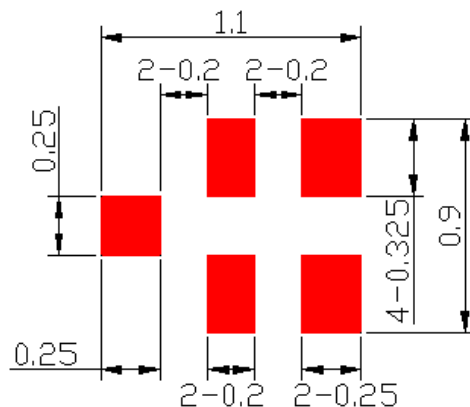

■ : Land Pattern
Unit: mm

TAI-SAW TECHNOLOGY CO., LTD.

TST DCC
Release document

F. Frequency Characteristics :

Frequency Response

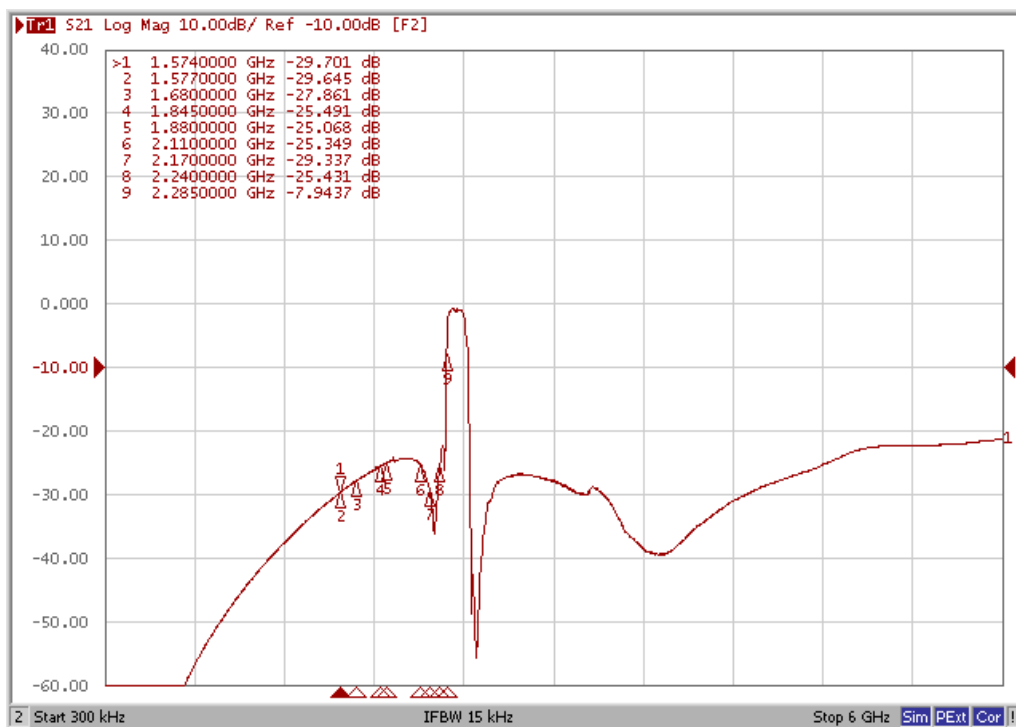
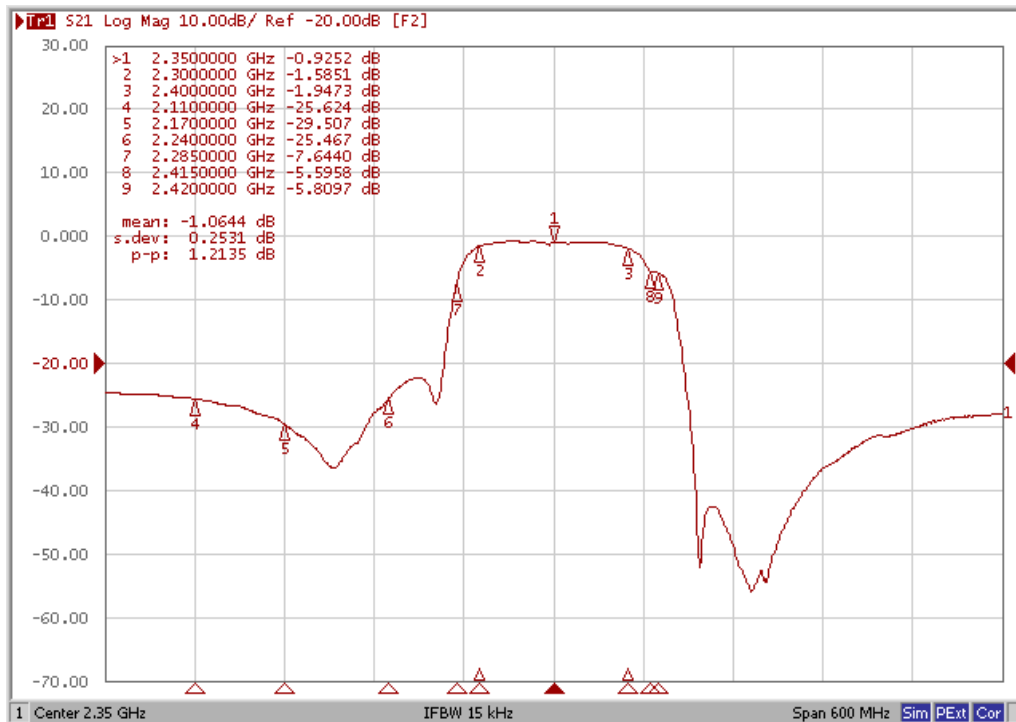

Reflection Functions :

VSWR

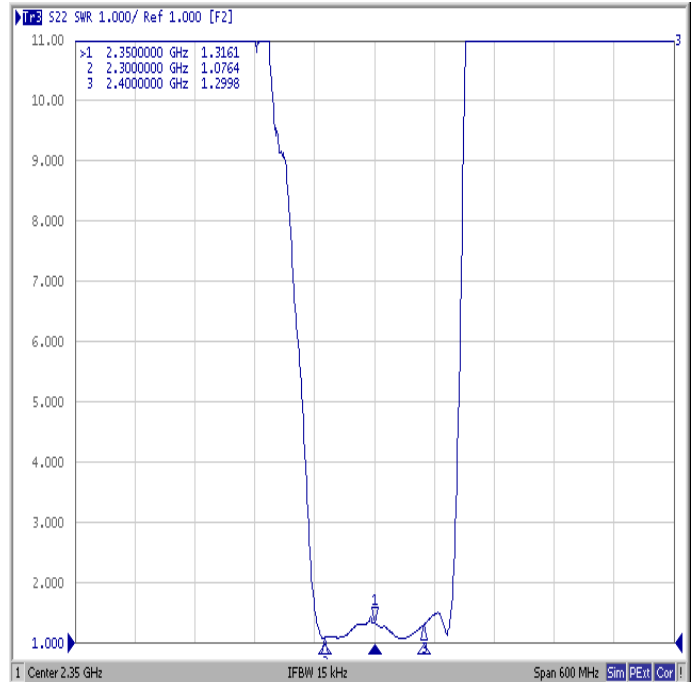
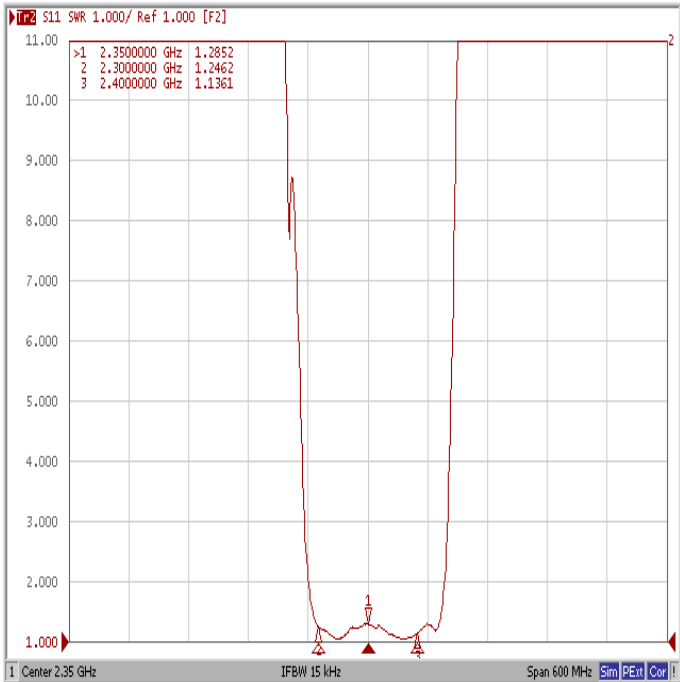

Smith Chart

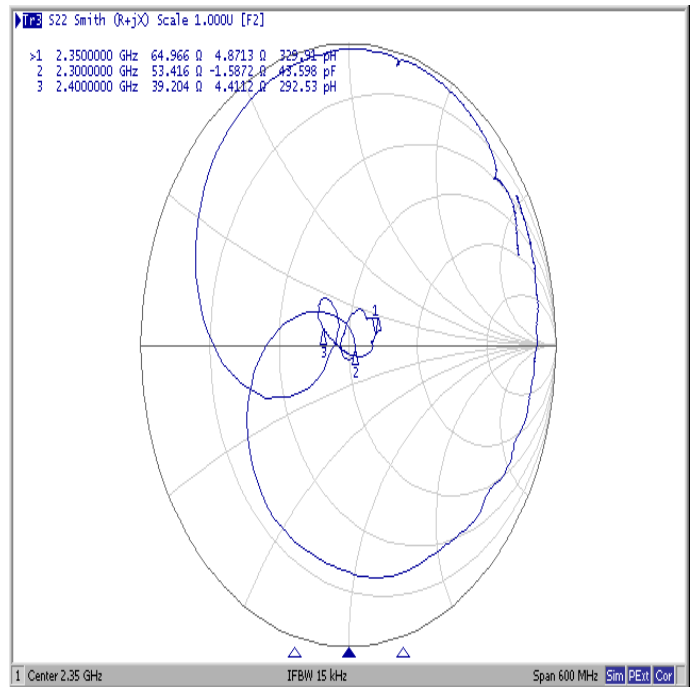
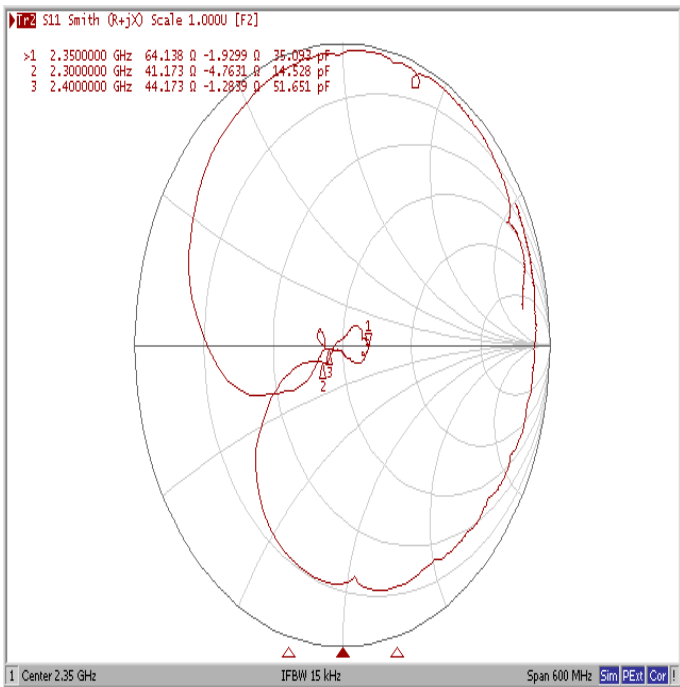

H. RECOMMENDED REFLOW PROFILE :

1. Preheating shall be fixed at 150~180°C for 60~90 seconds.
2. Ascending time to preheating temperature 150°C shall be 30 seconds min.
3. Heating shall be fixed at 220°C for 50~80 seconds and at 260°C+0/-5°C peak (20~40sec).
4. Time: 2 times.

